

Assembly and Commissioning Instructions
AC Drive
VersiDrive i .../PRO

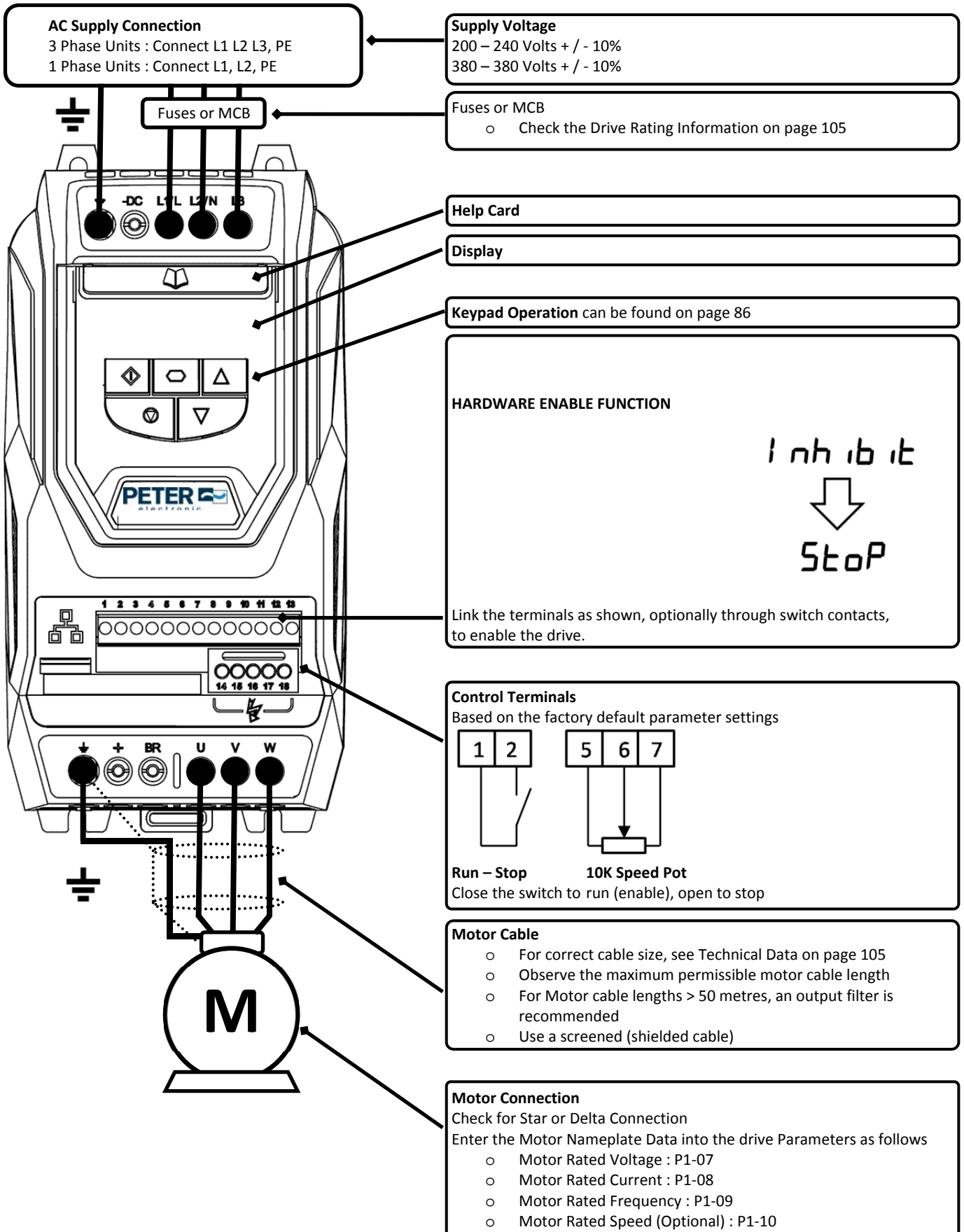

VD i PRO IP20 Easy Start Up Guide



VD i PRO IP 55 Easy Start Up Guide

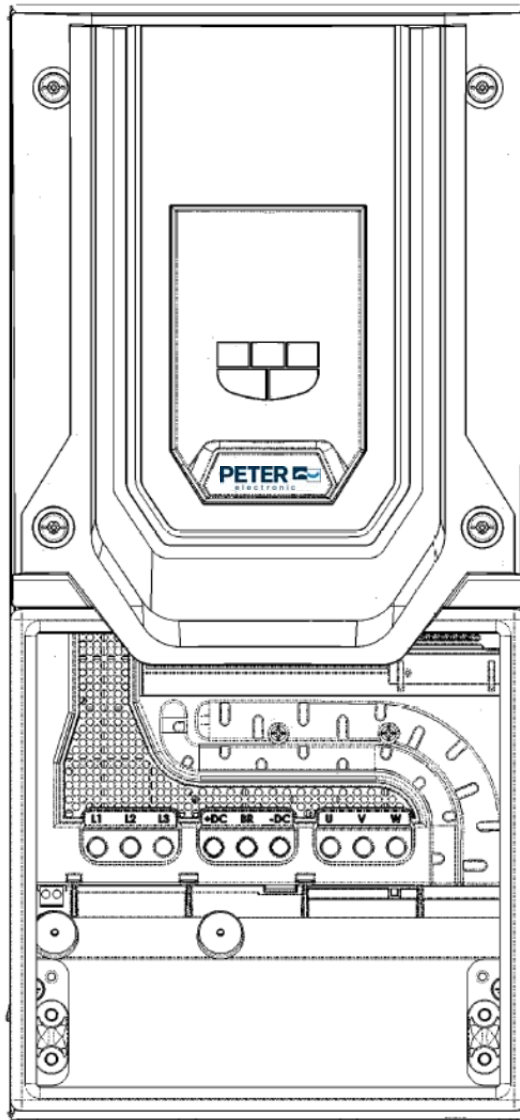

AC Supply Connection
 200 – 240 Volts + / - 10%
 380 – 380 Volts + / - 10%

L3 L2 L1 PE

Fuses or MCB
 Check drive
 Rating info on
 Page 105

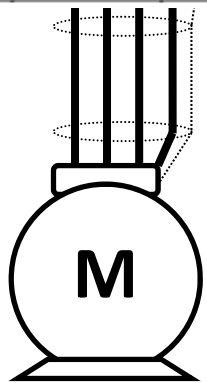

Display

Keypad Operation can be found on page 86

Control Terminals
 Based on factory settings

Safe Torque Off (STO)
 Link the terminals as shown above through the emergency stop circuit contacts

Run / Stop 10K Pot
 Close the switch to run (enable)
 Open the switch to stop

Motor Cable
 For correct cable size, see technical data on page 105
 Observe the maximum permissible motor cable length
 For Motor cable lengths > 50 metres, an output filter is recommended
 Use a screened (shielded cable). The shield should be bonded to earth at both ends

Motor Connection
 Check for Star or Delta Connection
 Enter the Motor Nameplate Data into the drive Parameters as follows
 Motor Rated Voltage : P1-07
 Motor Rated Current : P1-08
 Motor Rated Frequency : P1-09
 Motor Rated Speed (Optional) : P1-10

VD i PRO IP 66 Easy Start Up Guide

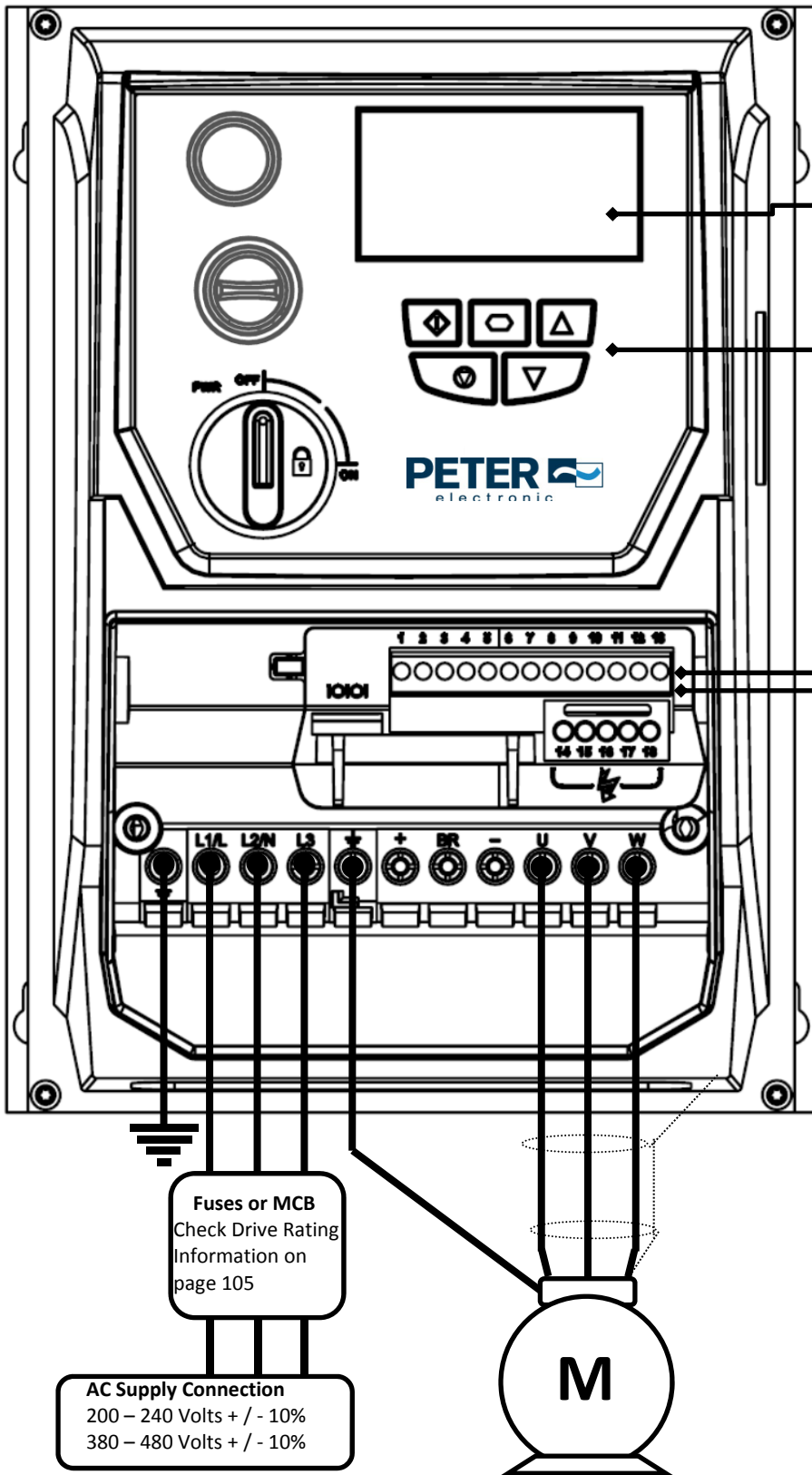

Display

Keypad Operation can be found on page 86

HARDWARE ENABLE

1	9	12	13
---	---	----	----

Link the terminals as shown Above, optionally through switch contacts to enable the drive

Control Terminals

1	2	5	6	7
---	---	---	---	---

Run / Stop **10K Pot**
Close the switch to run (enable)
Open the switch to stop

Motor Cable
For correct cable size, see technical data on page 105
Observe the maximum permissible motor cable length
For Motor cable lengths > 50 metres, an output filter is recommended
Use a screened (shielded) cable. The shield should be bonded to earth at both ends

Motor Connection
Check for Star or Delta Connection
Enter the Motor Nameplate Data into the drive Parameters as follows
Motor Rated Voltage : P1-07
Motor Rated Current : P1-08
Motor Rated Frequency : P1-09
Motor Rated Speed (Optional) : P1-10

Declaration of Conformity:

PETER electronic GmbH Co.KG hereby states that the "VersiDrive i PRO" product range conforms to the relevant safety provisions of the Low Voltage Directive 2006/95/EC and the EMC Directive 2004/108/EC and has been designed and manufactured in accordance with the following harmonised European standards:

EN 61800-5-1: 2003	Adjustable speed electrical power drive systems. Safety requirements. Electrical, thermal and energy.
EN 61800-3 2 nd Ed: 2004	Adjustable speed electrical power drive systems. EMC requirements and specific test methods
EN 55011: 2007	Limits and Methods of measurement of radio disturbance characteristics of industrial, scientific and medical (ISM) radio-frequency equipment (EMC)
EN60529 : 1992	Specifications for degrees of protection provided by enclosures

STO Function

VersiDrive i PRO incorporates a hardware STO (Safe Torque Off) Function, designed in accordance with the standards listed below.

Standard	Classification	Independent Approval
EN 61800-5-2:2007	Type 2	TUV
EN ISO 13849-1:2006	PL "d"	
EN 61508 (Part 1 to 7)	SIL 2	
EN60204-1	Uncontrolled Stop "Category 0"	
EN 62061	SIL CL 2	

Electromagnetic Compatibility

All „VersiDrive i PRO“s are designed with high standards of EMC in mind. All versions suitable for operation on Single Phase 230 volt and Three Phase 400 volt supplies and intended for use within the European Union are fitted with an internal EMC filter. This EMC filter is designed to reduce the conducted emissions back into the supply via the power cables for compliance with harmonised European standards.

It is the responsibility of the installer to ensure that the equipment or system into which the product is incorporated complies with the EMC legislation of the country of use. Within the European Union, equipment into which this product is incorporated must comply with the EMC Directive 2004/108/EC. When using an „VersiDrive i PRO“ with an internal or optional external filter, compliance with the following EMC Categories, as defined by EN61800-3:2004 can be achieved:

Drive Type / Rating	EMC Category		
	Cat C1	Cat C2	Cat C3
1 Phase, 230 Volt Input	No additional filtering required Use shielded motor cable		
3 Phase, 400 Volt Input IP20 & IP66 Models	Use Additional External Filter	No additional filtering required	
	Use Shielded Motor Cable		
3 Phase, 400 Volt Input IP55 Models	Use Additional External Filter	No Additional Filtering Required	
	Use Shielded Motor Cable		
Note	For motor cable lengths greater than 100m, an output dv / dt filter must be used, please refer to the PETER electronic Stock Drives Catalogue for further details		
	Vector Speed and Torque control modes may not operate correctly with long motor cables and output filters. It is recommended to operate in V/F mode only for cable lengths exceeding 50m		

All rights reserved. No part of this User Guide may be reproduced or transmitted in any form or by any means, electrical or mechanical including photocopying, recording or by any information storage or retrieval system without permission in writing from the publisher.

Copyright PETER electronic GmbH Co.KG © 2013

All PETER electronic VersiDrive i PRO units carry a 2 year warranty against manufacturing defects from the date of manufacture. The manufacturer accepts no liability for any damage caused during or resulting from transport, receipt of delivery, installation or commissioning. The manufacturer also accepts no liability for damage or consequences resulting from inappropriate, negligent or incorrect installation, incorrect adjustment of the operating parameters of the drive, incorrect matching of the drive to the motor, incorrect installation, unacceptable dust, moisture, corrosive substances, excessive vibration or ambient temperatures outside of the design specification. The local distributor may offer different terms and conditions at their discretion, and in all cases concerning warranty, the local distributor should be contacted first.

This user guide is the "original instructions" document. All non-English versions are translations of the "original instructions".

Contents of this User Guide are believed to be correct at the time of printing. In the interest of a commitment to a policy of continuous improvement, the manufacturer reserves the right to change the specification of the product or its performance or the contents of the User Guide without notice.

This User Guide is for use with version 1.30 Firmware. User Guide Revision 1.30.

PETER electronic GmbH Co.KG adopts a policy of continuous improvement and whilst every effort has been made to provide accurate and up to date information, the information contained in this User Guide should be used for guidance purposes only and does not form the part of any contract.





1. Introduction	67
1.1. Important safety information	67
2. General Information and Ratings.....	68
2.1. Drive model numbers – IP20.....	68
2.2. Drive model numbers – IP55.....	68
2.3. Drive model numbers – IP66.....	69
3. Mechanical Installation	70
3.1. General.....	70
3.2. Before Installation.....	70
3.3. UL Compliant Installation.....	70
3.4. Mechanical dimensions and mounting – IP20 Units.....	70
3.5. Mechanical dimensions and mounting – IP55 Units.....	71
3.6. Mechanical dimensions and mounting – IP66 Units.....	72
3.7. Guidelines for Enclosure mounting (IP20 Units).....	73
3.8. Mounting the Drive – IP20 Units.....	73
3.9. Guidelines for mounting (IP55 Units).....	74
3.10. Guidelines for mounting (IP66 Units)	74
3.11. Removing the Terminal Cover (IP55 Units).....	75
3.12. Removing the Terminal Cover (IP66 Units).....	76
3.13. Routine Maintenance.....	76
4. Electrical Installation	77
4.1. Grounding the Drive.....	77
4.2. Wiring Precautions.....	78
4.3. Incoming Power Connection.....	78
4.4. Operation of 3 Phase drives from a Single Phase Supply.....	79
4.5. Drive and Motor Connection	79
4.6. Motor Terminal Box Connections	79
4.7. Motor Thermal overload Protection.	79
4.8. Control Terminal Wiring.....	80
4.9. Connection Diagrams.....	80
4.10. Control Terminal Connections	81
4.11. Safe Torque Off.....	82
4.12. Connecting a Brake Resistor.....	85
5. Managing the Keypad.....	86
5.1. Keypad Layout and Function.....	86
5.2. Changing Parameters.....	86
5.3. Advanced Keypad Operation Short Cuts.....	87
5.4. Drive Operating Displays.....	87
5.5. Resetting Parameters to Factory Default Settings.....	88
5.6. Terminal Control	88
5.7. Keypad Control.....	89
5.8. Operating in Sensorless Vector Speed Control Mode.....	89
6. Parameters.....	90
6.1. Parameter Set Overview	90
6.2. Parameter Group 1 – Basic Parameters.....	90
7. Digital Input Functions	92
7.1. Digital Input Configuration Parameter P1-13.....	92
8. Extended Parameters	94
8.1. Parameter Group 2 - Extended parameters	94
8.2. Parameter Group 3 – PID Control	98
8.3. Parameter Group 4 – High Performance Motor Control.....	99
8.4. Parameter Group 5 – Communication Parameters	100
8.5. Parameter Group 0 – Monitoring Parameters (Read Only)	101
9. Serial communications	103
9.1. RS-485 communications	103
9.2. Modbus RTU Communications	103
10. Technical Data.....	105
10.1. Environmental	105
10.2. Input / Output Power and Current ratings.....	105
10.3. Additional Information for UL Approved Installations	107

10.4. Derating Information	108
11. Troubleshooting	109
11.1. Fault messages	109

1. Introduction

1.1. Important safety information

Please read the **IMPORTANT SAFETY INFORMATION** below, and all **Warning and Caution** information elsewhere.

	Danger : Indicates a risk of electric shock, which, if not avoided, could result in damage to the equipment and possible injury or death.		Danger : Indicates a potentially hazardous situation other than electrical, which if not avoided, could result in damage to property.
	<p>This variable speed drive product („VersiDrive i PRO“) is intended for professional incorporation into complete equipment or systems as part of a fixed installation. If installed incorrectly it may present a safety hazard. The „VersiDrive i PRO“ uses high voltages and currents, carries a high level of stored electrical energy, and is used to control mechanical plant that may cause injury. Close attention is required to system design and electrical installation to avoid hazards in either normal operation or in the event of equipment malfunction. Only qualified electricians are allowed to install and maintain this product.</p> <p>System design, installation, commissioning and maintenance must be carried out only by personnel who have the necessary training and experience. They must carefully read this safety information and the instructions in this Guide and follow all information regarding transport, storage, installation and use of the „VersiDrive i PRO“, including the specified environmental limitations.</p> <p>Do not perform any flash test or voltage withstand test on the „VersiDrive i PRO“. Any electrical measurements required should be carried out with the „VersiDrive i PRO“ disconnected.</p> <p>Electric shock hazard! Disconnect and ISOLATE the „VersiDrive i PRO“ before attempting any work on it. High voltages are present at the terminals and within the drive for up to 10 minutes after disconnection of the electrical supply. Always ensure by using a suitable multimeter that no voltage is present on any drive power terminals prior to commencing any work.</p> <p>Where supply to the drive is through a plug and socket connector, do not disconnect until 10 minutes have elapsed after turning off the supply.</p> <p>Ensure correct earthing connections. The earth cable must be sufficient to carry the maximum supply fault current which normally will be limited by the fuses or MCB. Suitably rated fuses or MCB should be fitted in the mains supply to the drive, according to any local legislation or codes.</p> <p>Do not carry out any work on the drive control cables whilst power is applied to the drive or to the external control circuits.</p>		
	<p>Within the European Union, all machinery in which this product is used must comply with Directive 2006/42/EC, Safety of Machinery. In particular, the machine manufacturer is responsible for providing a main switch and ensuring the electrical equipment complies with EN60204-1.</p> <p>The level of integrity offered by the „VersiDrive i PRO“ control input functions (excluding the ‘Safe Torque Free Input’) – for example stop/start, forward/reverse and maximum speed, is not sufficient for use in safety-critical applications without independent channels of protection. All applications where malfunction could cause injury or loss of life must be subject to a risk assessment and further protection provided where needed.</p> <p>The driven motor can start at power up if the enable input signal is present.</p> <p>The STOP function does not remove potentially lethal high voltages. ISOLATE the drive and wait 10 minutes before starting any work on it. Never carry out any work on the Drive, Motor or Motor cable whilst the input power is still applied.</p> <p>The „VersiDrive i PRO“ can be programmed to operate the driven motor at speeds above or below the speed achieved when connecting the motor directly to the mains supply. Obtain confirmation from the manufacturers of the motor and the driven machine about suitability for operation over the intended speed range prior to machine start up.</p> <p>Do not activate the automatic fault reset function on any systems whereby this may cause a potentially dangerous situation.</p> <p>The „VersiDrive i PRO“ has an Ingress Protection rating of IP20 or IP55 depending on the model. IP20 units must be installed in a suitable enclosure.</p> <p>„VersiDrive i PRO“s are intended for indoor use only.</p> <p>When mounting the drive, ensure that sufficient cooling is provided. Do not carry out drilling operations with the drive in place, dust and swarf from drilling may lead to damage.</p> <p>The entry of conductive or flammable foreign bodies should be prevented. Flammable material should not be placed close to the drive</p> <p>Relative humidity must be less than 95% (non-condensing).</p> <p>Ensure that the supply voltage, frequency and no. of phases (1 or 3 phase) correspond to the rating of the „VersiDrive i PRO“ as delivered.</p> <p>Never connect the mains power supply to the Output terminals U, V, W.</p> <p>Do not install any type of automatic switchgear between the drive and the motor</p> <p>Wherever control cabling is close to power cabling, maintain a minimum separation of 100 mm and arrange crossings at 90 degrees</p> <p>Ensure that all terminals are tightened to the appropriate torque setting</p> <p>Do not attempt to carry out any repair of the „VersiDrive i PRO“. In the case of suspected fault or malfunction, contact your local PETER electronic Sales Partner for further assistance.</p>		

2. General Information and Ratings

2.1. Drive model numbers – IP20

200-240V ±10% - 1-Phase Input					
Model	Order Nr	kW	PS	Output current (A)	Size
VD i 075-Pro-IP20	2I100.23075	0,75	1	4,3	2
VD i 150-Pro-IP20	2I100.23150	1,5	2	7	2
VD i 220-Pro-IP20	2I100.23220	2,2	3	10,5	2
200-240V ±10% - 3- Phase Input					
Model	Order Nr	kW	PS	Output current (A)	Size
VD i 075-3Pro-IP20-240V	2I102.23075	0,75	1	4,3	2
VD i 150-3Pro-IP20-240V	2I102.23150	1,5	2	7	2
VD i 220-3Pro-IP20-240V	2I102.23220	2,2	3	10,5	2
VD i 400-3Pro-IP20-240V	2I102.23004	4,0	5	18	3
380-480V ±10% - 3- Phase Input					
Model	Order Nr	kW	PS	Output current (A)	Size
VD i 075-3Pro-IP20	2I100.40075	0,75	1	2,2	2
VD i 150-3Pro-IP20	2I100.40150	1,5	2	4,1	2
VD i 220-3Pro-IP20	2I100.40220	2,2	3	5,8	2
VD i 400-3Pro-IP20	2I100.40004	4	5	9,5	2
VD i 550-3Pro-IP20	2I100.40005	5,5	7,5	14	3
VD i 750-3Pro-IP20	2I100.40075	7,5	10	18	3
VD i 1100-Pro-IP20	2I100.40011	11	15	24	3

2.2. Drive model numbers – IP55

200-240V ±10% - 3- Phase Input					
Model	Order Nr	kW	PS	Output current (A)	Size
VD i 550-3Pro-IP55-240V	2I006.23005	5,5	7,5	25	4
VD i 750-3Pro-IP55-240V	2I006.23007	7,5	10	39	4
VD i 1100-3Pro-IP55-240V	2I006.23011	11	15	46	4
VD i 1500-3Pro-IP55-240V	2I006.23015	15	20	61	5
VD i 1850-3Pro-IP55-240V	2I006.23018	18,5	25	72	5
VD i 2200-3Pro-IP55-240V	2I006.23022	22	30	90	6
VD i 3000-3Pro-IP55-240V	2I006.23030	30	40	110	6
VD i 3700-3Pro-IP55-240V	2I006.23037	37	50	150	6
VD i 4500-3Pro-IP55-240V	2I006.23045	45	60	180	6
VD i 5500-3Pro-IP55-240V	2I006.23055	55	75	202	7
VD i 7500-3Pro-IP55-240V	2I006.23075	75	100	240	7
VD i 9000-3Pro-IP55-240V	2I006.23090	90	120	300	7
380-480V ±10% - 3- Phase Input					
Model	Order Nr	kW	PS	Output current (A)	Size
VD i 1100-3Pro-IP55	2I101.40011	11	15	25	4
VD i 1500-3Pro-IP55	2I101.40015	15	20	30	4
VD i 1850-3Pro-IP55	2I101.40018	18,5	25	39	4
VD i 2200-3Pro-IP55	2I101.40022	22	30	46	4
VD i 3000-3Pro-IP55	2I101.40030	30	40	61	5
VD i 3700-3Pro-IP55	2I101.40037	37	50	72	5
VD i 4500-3Pro-IP55	2I101.40045	45	60	90	6
VD i 5500-3Pro-IP55	2I101.40055	55	75	110	6
VD i 7500-3Pro-IP55	2I101.40075	75	100	150	6
VD i 9000-3Pro-IP55	2I101.40090	90	150	180	6
VD i 11000-3Pro-IP55	2I101.40110	110	160	202	7
VD i 13200-3Pro-IP55	2I101.40132	132	200	240	7
VD i 16000-3Pro-IP55	2I101.40160	160	250	300	7

2.3. Drive model numbers – IP66

200-240V ±10% - 1 phase input switched					
Model	Order Nr	kW	PS	Output current (A)	Size
VD i 075-Pro-IP66 switched	21107.23075	0,75	1	4,3	2
VD i 150-Pro-IP66 switched	21107.23150	1,5	2	7	2
VD i 220-Pro-IP66 switched	21107.23220	2,2	3	10,5	2
380-480V ±10% - 3 phase input switched					
Model	Order Nr	kW	PS	Output current (A)	Size
VD i 075-3Pro-IP66 switched	21109.40075	0,75	1	2,2	2
VD i 150-3Pro-IP66 switched	21109.40150	1,5	2	4,1	2
VD i 220-3Pro-IP66 switched	21109.40220	2,2	3	5,8	2
VD i 400-3Pro-IP66 switched	21109.40004	4	5	9,5	2
VD i 550-3Pro-IP66 switched	21109.40005	5,5	7,5	14	3
VD i 750-3Pro-IP66 switched	21109.40075	7,5	10	18	3
200-240V ±10% - 1 phase input non-switched					
Model	Order Nr	kW	PS	Output current (A)	Size
VD i 075-Pro-IP66 un-switched	21103.23075	0,75	1	4,3	2
VD i 150-Pro-IP66 un-switched	21103.23150	1,5	2	7	2
VD i 220-Pro-IP66 un-switched	21103.23220	2,2	3	10,5	2
380-480V ±10% - 3 phase input non-switched					
Model	Order Nr	kW	PS	Output current (A)	Size
VD i 075-3Pro-IP66 un-switched	21105.40075	0,75	1	2,2	2
VD i 150-3Pro-IP66 un-switched	21105.40150	1,5	2	4,1	2
VD i 220-3Pro-IP66 un-switched	21105.40220	2,2	3	5,8	2
VD i 400-3Pro-IP66 un-switched	21105.40004	4	5	9,5	2
VD i 550-3Pro-IP66 un-switched	21105.40005	5,5	7,5	14	3
VD i 750-3Pro-IP66 un-switched	21105.40075	7,5	10	18	3

3. Mechanical Installation

3.1. General

- The „VersiDrive i PRO“ should be mounted in a vertical position only on a flat, flame resistant vibration free mounting using the integral holes.
- The „VersiDrive i PRO“ must be installed in a pollution degree 1 or 2 environment only.
- Do not mount flammable material close to the „VersiDrive i PRO“
- Ensure that the minimum cooling air gaps, as detailed in section 3.6 and 3.7 are left clear
- Ensure that the ambient temperature range does not exceed the permissible limits for the „VersiDrive i PRO“ given in section 10.1
- Provide suitable clean, moisture and contaminant free cooling air sufficient to fulfil the cooling requirements of the „VersiDrive i PRO“

3.2. Before Installation

- Carefully Unpack the „VersiDrive i PRO“ and check for any signs of damage. Notify the shipper immediately if any exist.
- Check the drive rating label to ensure it is of the correct type and power requirements for the application.
- Store the „VersiDrive i PRO“ in its box until required. Storage should be clean and dry and within the temperature range –40°C to +60°C

3.3. UL Compliant Installation

Note the following for UL-compliant installation:

- The drive can be operated within an ambient temperature range as stated in section 10.1
- For IP20 units, installation is required in a pollution degree 1 environment
- For IP55 units, installation in a pollution degree 2 environment is permissible
- UL Listed ring terminals / lugs must be used for all bus bar and grounding connections

3.4. Mechanical dimensions and mounting – IP20 Units

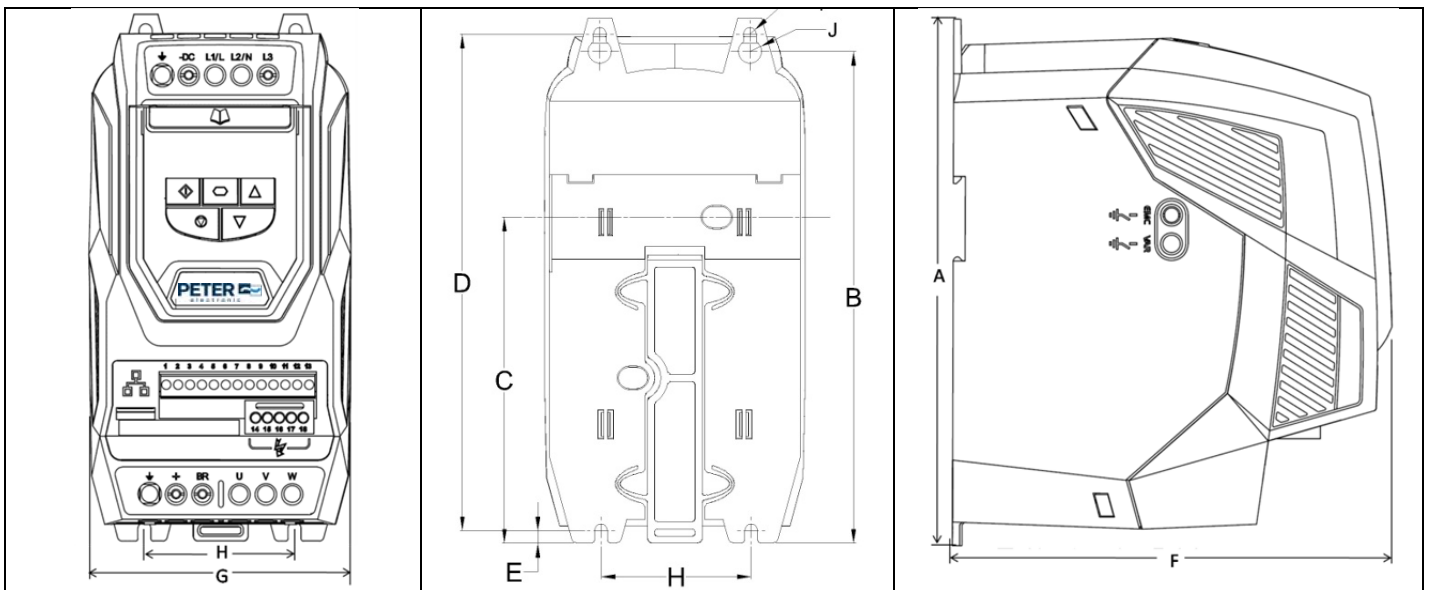

Drive Size	A		B		C		D		E		F		G		H		I		J	
	mm	in	mm	in	mm	in	mm	in	mm	in	mm	in	mm	in	mm	in	mm	in	mm	in
2	221	8.70	207	8.15	137	5.39	209	8.23	5.3	0.21	185	7.28	112	4.41	63	2.48	5.5	0.22	10	0.39
3	261	10.28	246	9.69	-	-	247	9.72	6	0.24	205	8.07	131	5.16	80	3.15	5.5	0.22	10	0.39

Mounting Bolts

All Frame Sizes : 4 x M4 (#8)

Tightening Torques

Control Terminal Torque Settings : All Sizes : 0.8 Nm (7 lb-in)

Power Terminal Torque Settings : All Sizes : 1 Nm (8.85 lb-in)

3.5. Mechanical dimensions and mounting – IP55 Units

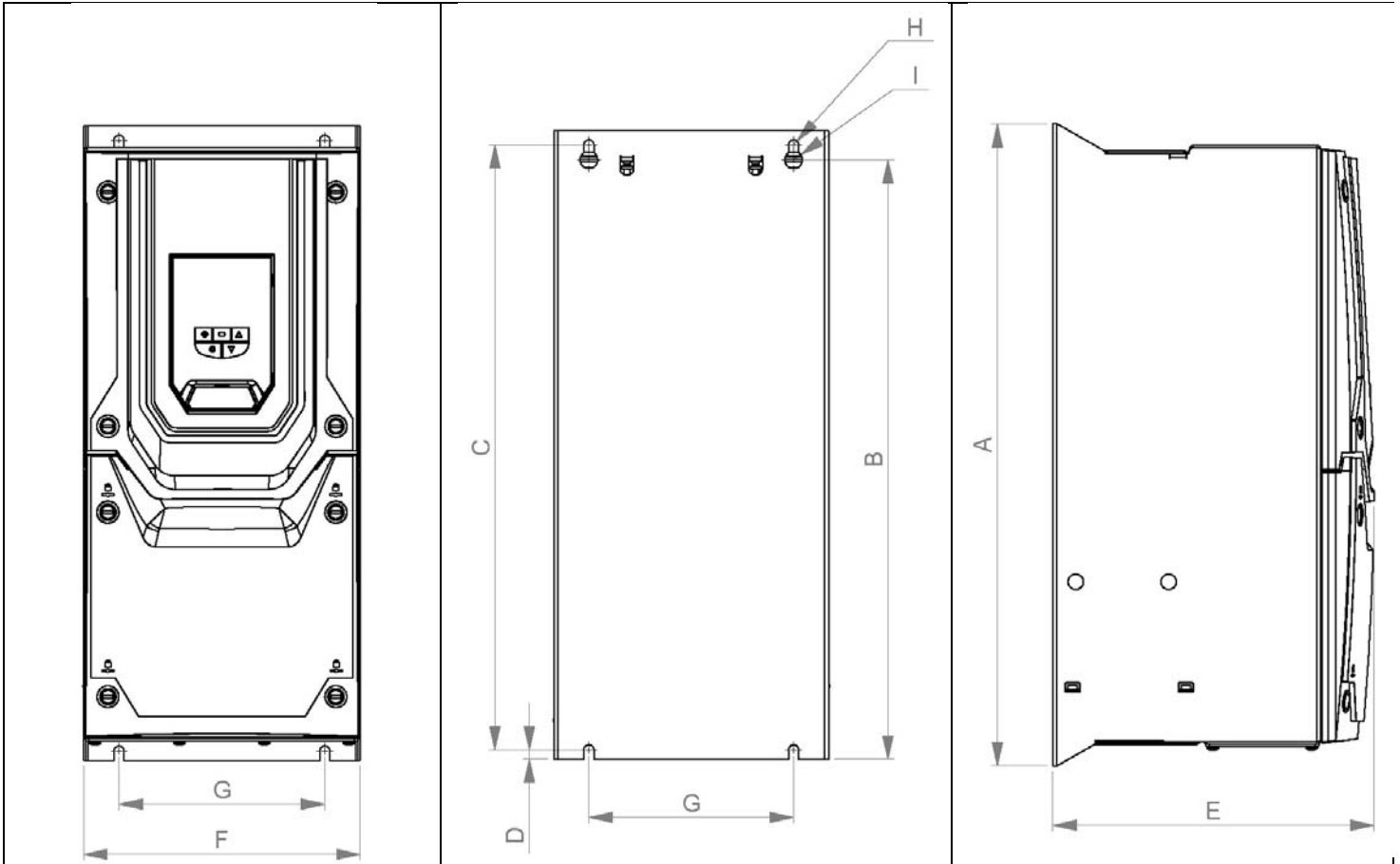

Drive Size	A		B		C	D		E		F		G		H		I		
	mm	in	mm	in	mm	in	mm	in	mm	in	mm	in	mm	in	mm	in		
4	450	17.72	428	16.85	433	17.05	8	0.31	240	9.45	171	6.73	110	4.33	4.25	0.17	7.5	0.30
5	540	21.26	515	20.28	520	20.47	8	0.31	270	10.63	235	9.25	175	6.89	4.25	0.17	7.5	0.30
6	865	34.06	830	32.68	840	33.07	10	0.39	330	12.99	330	12.99	200	7.87	5.5	0.22	11	0.43
7	1280	50.39	1245	49.02	1255	49.41	10	0.39	360	14.17	330	12.99	200	7.87	5.5	0.22	11	0.43

Mounting Bolts

- Frame Size 4 : M8 (5/16 UNF)
- Frame Size 5 : M8 (5/16 UNF)
- Frame Size 6 : M10 (3/8 UNF)
- Frame Size 7 : M10 (3/8 UNF)

Tightening Torques

- Control Terminal Torque Settings : All Sizes : 0.8 Nm (7 lb-in)
- Power Terminal Torque Settings : Frame Size 4 : 4 Nm (3 lb-ft)
- Frame Size 5 : 15 Nm (11.1 lb-ft)
- Frame Size 6 : 20 Nm (15 lb-ft)
- Frame Size 7 : 20 Nm (15 lb-ft)

3.6. Mechanical dimensions and mounting – IP66 Units

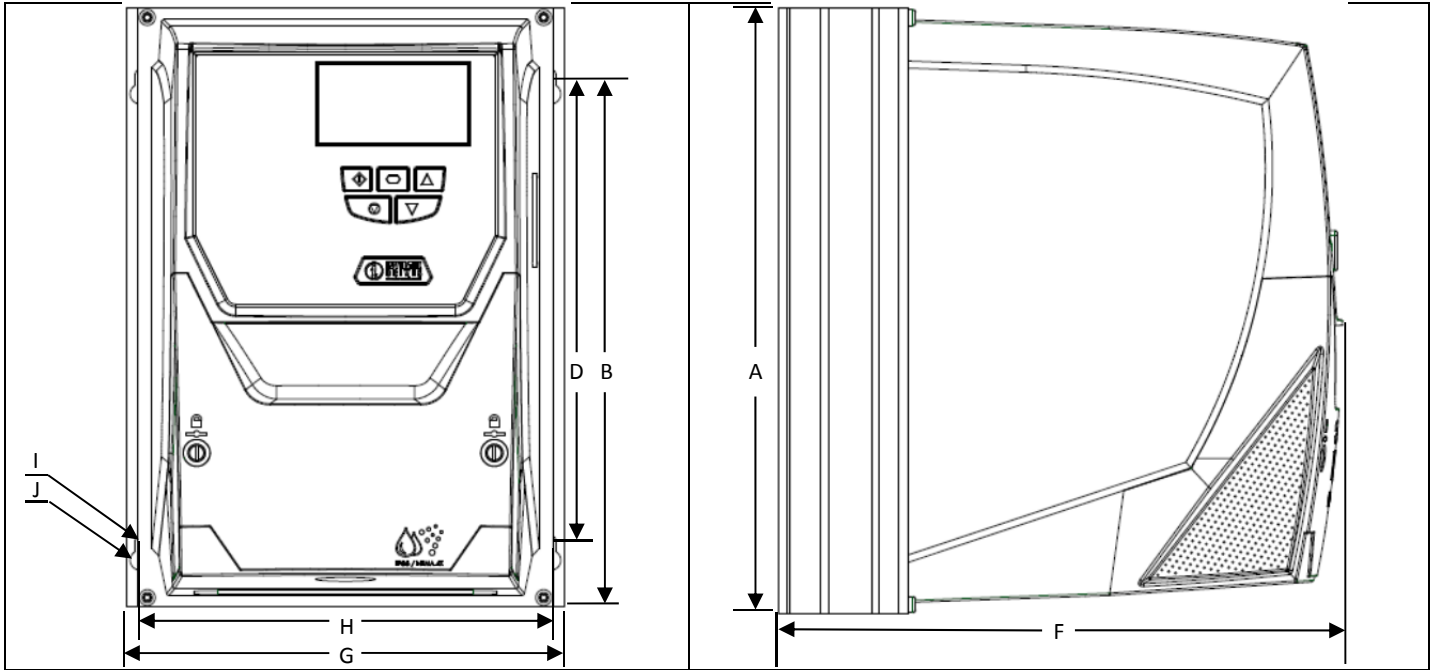

Note : Unit shown is a non-switched unit with optional OLED display

Drive Size	A		B		D		F		G		H		I		J		Weight	
	mm	in	mm	in	mm	in	mm	in	mm	in	mm	in	mm	in	mm	in	Kg	lb
2	257	10.12	220	8.66	200	7.87	29	1.12	239	9.41	188	7.40	178	7.01	4.2	0.17	4.8	10.6
3	310	12.20	277	10.89	252	9.90	33	1.31	251	9.88	211	8.29	200	7.87	4.2	0.17	7.3	16.1

Mounting Bolt Sizes

All Frame Sizes 4 x M4 (#8)

Tightening Torques

Control Terminal Torque Settings : All Sizes : 0.8 Nm (7 lb-in)
 Power Terminal Torque Settings : Frame Size 2 : 1.2 – 1.5 Nm (10 – 15 lb-in)

3.7. Guidelines for Enclosure mounting (IP20 Units)

- Installation should be in a suitable enclosure, according to EN60529 or other relevant local codes or standards.
- Enclosures should be made from a thermally conductive material.
- Where vented enclosures are used, there should be venting above the drive and below the drive to ensure good air circulation – see the diagram below. Air should be drawn in below the drive and expelled above the drive.
- In any environments where the conditions require it, the enclosure must be designed to protect the „VersiDrive i PRO“ against ingress of airborne dust, corrosive gases or liquids, conductive contaminants (such as condensation, carbon dust, and metallic particles) and sprays or splashing water from all directions.
- High moisture, salt or chemical content environments should use a suitably sealed (non-vented) enclosure.

The enclosure design and layout should ensure that the adequate ventilation paths and clearances are left to allow air to circulate through the drive heatsink. PETER electronic recommend the following minimum sizes for drives mounted in non-ventilated metallic enclosures:-

Drive Size	X Above & Below		Y Either Side		Z Between		Recommended airflow CFM (ft ³ /min)
	mm	in	mm	in	mm	in	
2	75	2.95	50	1.97	46	1.81	11
3	100	3.94	50	1.97	52	2.05	26

Note :
Dimension Z assumes that the drives are mounted side-by-side with no clearance.

Typical drive heat losses are 3% of operating load conditions.

Above are guidelines only and the operating ambient temperature of the drive **MUST** be maintained at all times.

3.8. Mounting the Drive – IP20 Units

- IP20 Units are intended for installation within a control cabinet.
- When mounting with screws
 - Using the drive as a template, or the dimensions shown above, mark the locations for drilling
 - Ensure that when mounting locations are drilled, the dust from drilling does not enter the drive
 - Mount the drive to the cabinet backplate using suitable M5 mounting screws
 - Position the drive, and tighten the mounting screws securely
- When Din Rail Mounting (Frame Size 2 Only)
 - Locate the DIN rail mounting slot on the rear of the drive onto the top of the DIN rail first
 - Press the bottom of the drive onto the DIN rail until the lower clip attaches to the DIN rail
 - If necessary, use a suitable flat blade screw driver to pull the DIN rail clip down to allow the drive to mount securely on the rail
 - To remove the drive from the DIN rail, use a suitable flat blade screwdriver to pull the release tab downwards, and lift the bottom of the drive away from the rail first

3.9. Guidelines for mounting (IP55 Units)

- Before mounting the drive, ensure that the chosen location meets the environmental condition requirements for the drive shown in section 10.1
- The drive must be mounted vertically, on a suitable flat surface
- The minimum mounting clearances as shown in the table below must be observed
- The mounting site and chosen mountings should be sufficient to support the weight of the drives

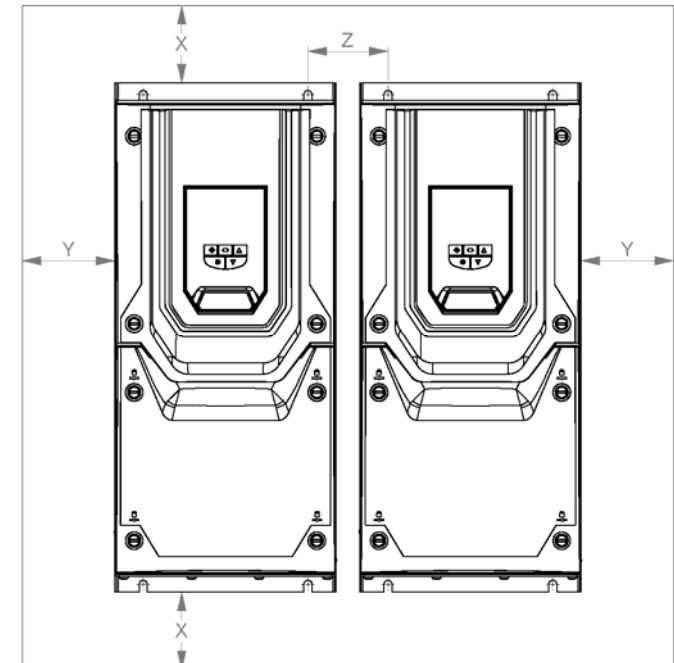

The diagram shows two drive units side-by-side. Dimension X is the vertical clearance above and below the unit. Dimension Y is the horizontal clearance on either side. Dimension Z is the horizontal clearance between the two units.

Drive Size	X Above & Below		Y Either Side	
	mm	in	mm	in
4	200	7.87	10	0.39
5	200	7.87	10	0.39
6	200	7.87	10	0.39
7	200	7.87	10	0.39

Note :
 Typical drive heat losses are approximately 3% of operating load conditions.

Above are guidelines only and the operating ambient temperature of the drive **MUST** be maintained at all times.

- Using the drive as a template, or the dimensions shown above, mark the locations required for drilling
- Suitable cable glands to maintain the IP protection of the drive are required. Gland sizes should be selected based on the number and size of the required connection cables. Drives are supplied with a plain, undrilled gland plate to allow the correct hole sizes to be cut as required. Remove the gland plate from the drive prior to drilling.

3.10. Guidelines for mounting (IP66 Units)

- Before mounting the drive, ensure that the chosen location meets the environmental condition requirements for the drive shown in section 10.1
- The drive must be mounted vertically, on a suitable flat surface
- The minimum mounting clearances as shown in the table below must be observed
- The mounting site and chosen mountings should be sufficient to support the weight of the drives

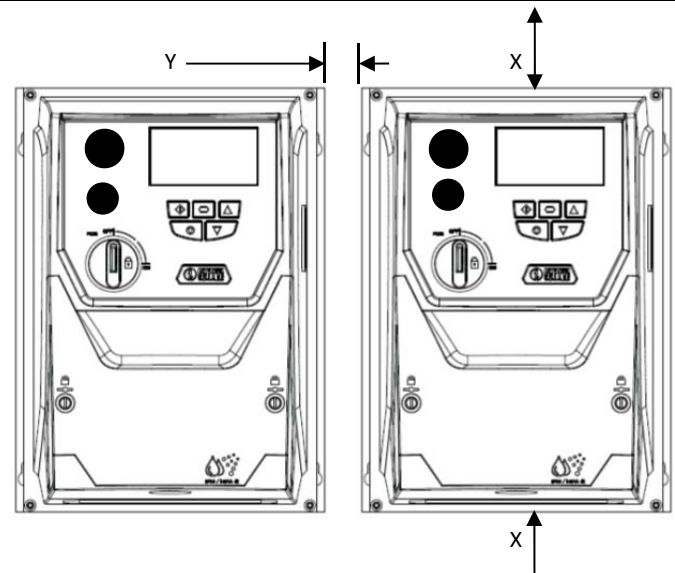

The diagram shows two drive units side-by-side. Dimension X is the vertical clearance above and below the unit. Dimension Y is the horizontal clearance on either side.

Drive Size	X Above & Below		Y Either Side	
	mm	in	mm	in
2	200	7.87	10	0.39
3	200	7.87	10	0.39

Note :
 Typical drive heat losses are approximately 3% of operating load conditions.

Above are guidelines only and the operating ambient temperature of the drive **MUST** be maintained at all times.

Cable Gland Sizes

Frame	Power Cable	Motor Cable	Control Cables
2	M25 (PG21)	M25 (PG21)	M20 (PG13.5)
3	M25 (PG21)	M25 (PG21)	M20 (PG13.5)

- Using the drive as a template, or the dimensions shown above, mark the locations required for drilling
- Suitable cable glands to maintain the ingress protection of the drive are required. Gland holes for power and motor cables are pre-moulded into the drive enclosure, recommended gland sizes are shown above. Gland holes for control cables may be cut as required.

Removing the Terminal Cover (IP55 Units)

3.11.1. Frame Size 4

3.11.2. Frame Size 5

Using a suitable flat blade screwdriver, rotate the two retaining screws indicated until the screw slot is vertical.

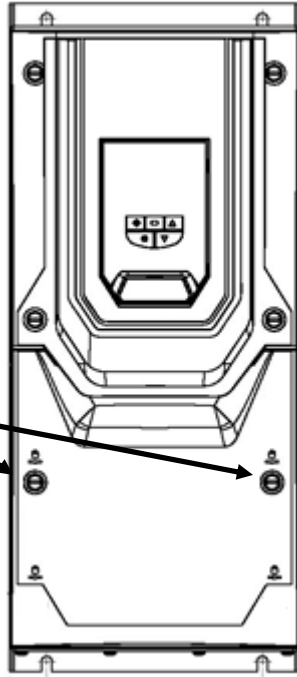

Using a suitable flat blade screwdriver, rotate the four retaining screws indicated until the screw slot is vertical.

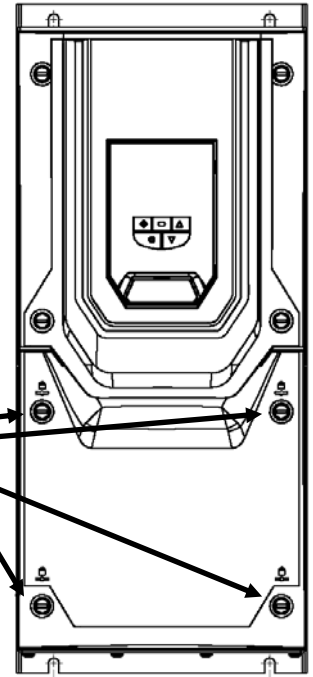

Terminal Cover Release Screws

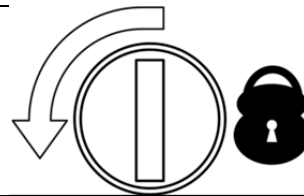
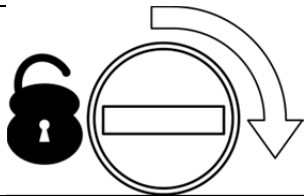

3.11.3. Frame Size 6

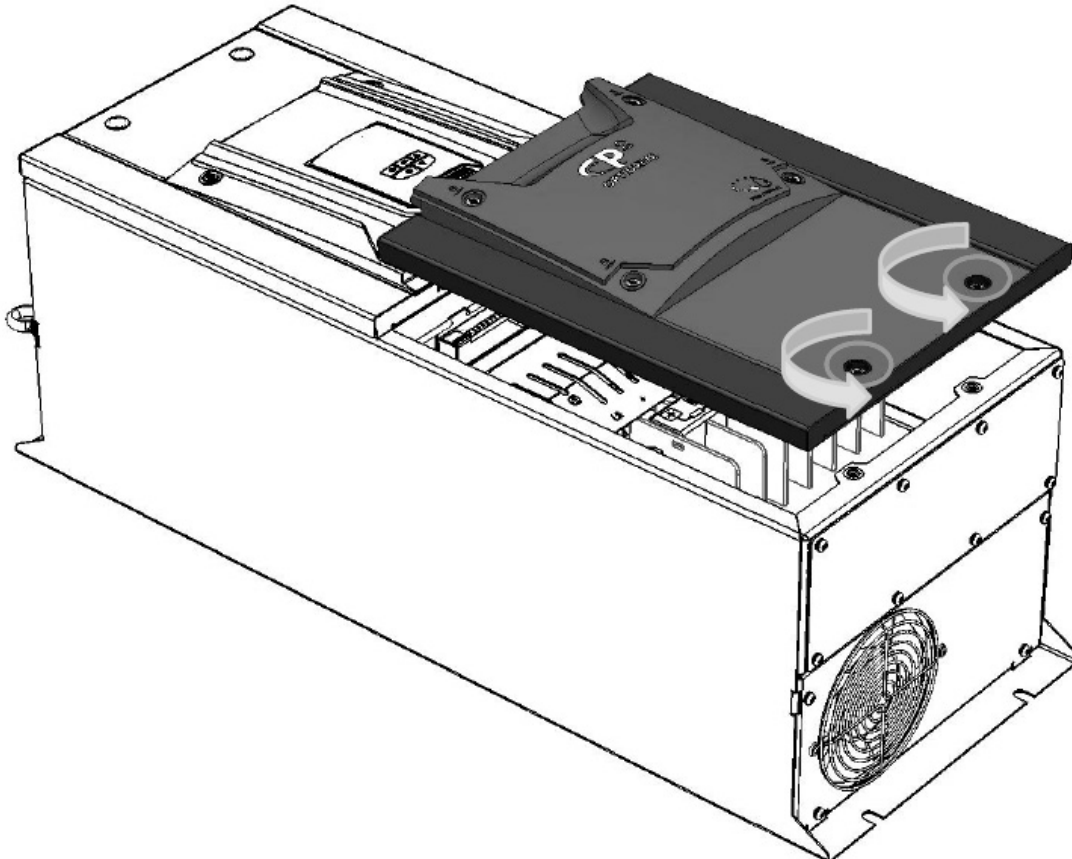

Remove the two screws indicated, lift the cover forwards and off. To refit the cover, slide the top locating lugs upwards under the top cover, then re-fasten the lower cover screws

Removing the Terminal Cover (IP66 Units)

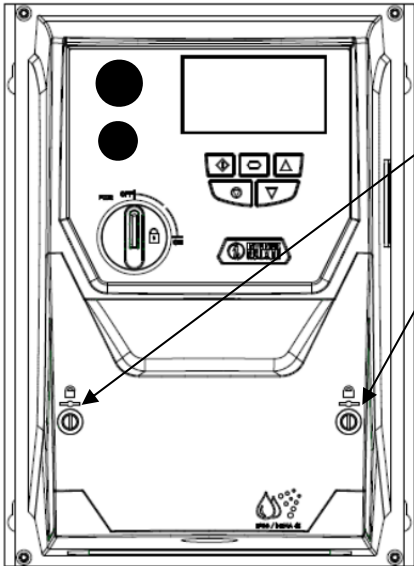
3.12.1. Frame Sizes 2 & 3	
	<p>Using a suitable flat blade screwdriver, rotate the two retaining screws indicated until the screw slot is vertical.</p>

3.13. Routine Maintenance

The drive should be included within the scheduled maintenance program so that the installation maintains a suitable operating environment, this should include:

- Ambient temperature is at or below that set out in the “Environment” section.
- Heat sink fans freely rotating and dust free.
- The Enclosure in which the drive is installed should be free from dust and condensation; furthermore ventilation fans and air filters should be checked for correct air flow.

Checks should also be made on all electrical connections, ensuring screw terminals are correctly torqued; and that power cables have no signs of heat damage.

4. Electrical Installation

4.1. Grounding the Drive



This manual is intended as a guide for proper installation. PETER electronic GmbH & Co. KG cannot assume responsibility for the compliance or the non-compliance to any code, national, local or otherwise, for the proper installation of this drive or associated equipment. A hazard of personal injury and/or equipment damage exists if codes are ignored during installation.



This „VersiDrive i PRO“ contains high voltage capacitors that take time to discharge after removal of the main supply. Before working on the drive, ensure isolation of the main supply from line inputs. Wait ten (10) minutes for the capacitors to discharge to safe voltage levels. Failure to observe this precaution could result in severe bodily injury or loss of life.



Only qualified electrical personnel familiar with the construction and operation of this equipment and the hazards involved should install, adjust, operate, or service this equipment. Read and understand this manual and other applicable manuals in their entirety before proceeding. Failure to observe this precaution could result in severe bodily injury or loss of life.

4.1.1. Recommended installation for EMC compliance.

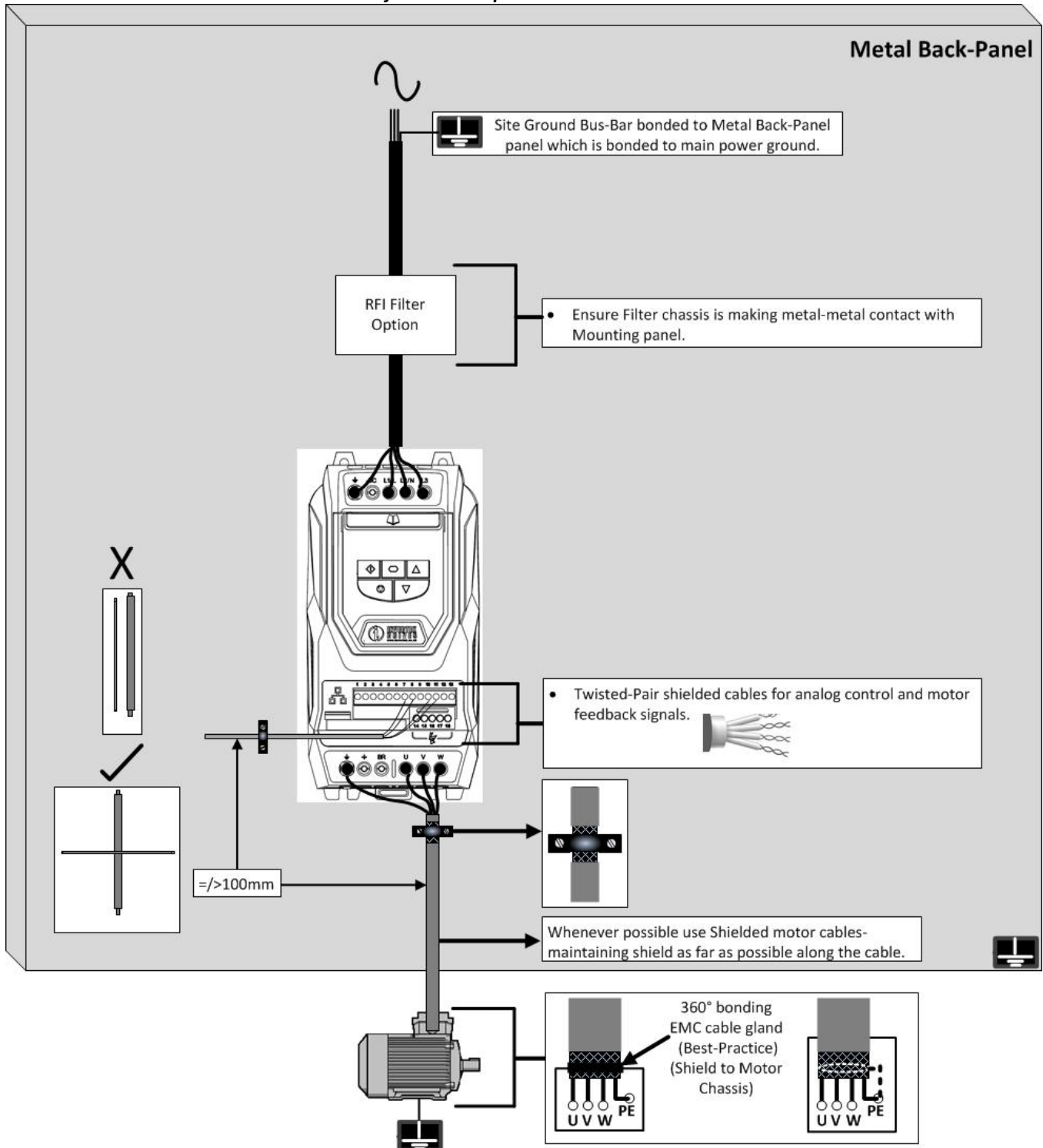

4.1.2. Grounding Guidelines

The ground terminal of each „VersiDrive i PRO“ should be individually connected DIRECTLY to the site ground bus bar (through the filter if installed). „VersiDrive i PRO“ ground connections should not loop from one drive to another, or to, or from any other equipment. Ground loop impedance must conform to local industrial safety regulations. To meet UL regulations, UL approved ring crimp terminals should be used for all ground wiring connections.

The drive Safety Ground must be connected to system ground. Ground impedance must conform to the requirements of national and local industrial safety regulations and/or electrical codes. The integrity of all ground connections should be checked periodically.

4.1.3. Protective Earth Conductor

The Cross sectional area of the PE Conductor must be at least equal to that of the incoming supply conductor.

4.1.4. Safety Ground 

This is the safety ground for the drive that is required by code. One of these points must be connected to adjacent building steel (girder, joist), a floor ground rod, or bus bar. Grounding points must comply with national and local industrial safety regulations and/or electrical codes.

4.1.5. Motor Ground

The motor ground must be connected to one of the ground terminals on the drive.

4.1.6. Ground Fault Monitoring

As with all inverters, a leakage current to earth can exist. The „VersiDrive i PRO“ is designed to produce the minimum possible leakage current whilst complying with worldwide standards. The level of current is affected by motor cable length and type, the effective switching frequency, the earth connections used and the type of RFI filter installed. If an ELCB (Earth Leakage Circuit Breaker) is to be used, the following conditions apply: -

- A Type B Device must be used
- The device must be suitable for protecting equipment with a DC component in the leakage current
- Individual ELCBs should be used for each „VersiDrive i PRO“

4.1.7. Shield Termination (Cable Screen)

The safety ground terminal provides a grounding point for the motor cable shield. The motor cable shield connected to this terminal (drive end) should also be connected to the motor frame (motor end). Use a shield terminating or EMI clamp to connect the shield to the safety ground terminal.

4.2. Wiring Precautions

Connect the „VersiDrive i PRO“ according to section 4.3 / 4.5 and 4.8, ensuring that motor terminal box connections are correct. There are two connections in general: Star and Delta. It is essential to ensure that the motor is connected in accordance with the voltage at which it will be operated. For more information, refer to section 4.6.

It is recommended that the power cabling should be 4-core PVC-insulated screened cable, laid in accordance with local industrial regulations and codes of practice.

4.3. Incoming Power Connection

- For 1 phase supply power should be connected to L1/L, L2/N.
- For 3 phase supplies power should be connected to L1, L2, and L3. Phase sequence is not important.
- For compliance with CE and C Tick EMC requirements, a symmetrical shielded cable is recommended.
- A fixed installation is required according to IEC61800-5-1 with a suitable disconnecting device installed between the „VersiDrive i PRO“ and the AC Power Source. The disconnecting device must conform to the local safety code / regulations (e.g. within Europe, EN60204-1, Safety of machinery).
- The cables should be dimensions according to any local codes or regulations. Guideline dimensions are given in section 10.4.
- Suitable fuses to provide wiring protection of the input power cable should be installed in the incoming supply line, according to the data in section 10.4. The fuses must comply with any local codes or regulations in place. In general, type gG (IEC 60269) or UL type T fuses are suitable; however in some cases type aR fuses may be required. The operating time of the fuses must be below 0.5 seconds.
- Where allowed by local regulations, suitably dimensioned type B MCB circuit breakers of equivalent rating may be utilised in place of fuses, providing that the clearing capacity is sufficient for the installation.
- When the power supply is removed from the drive, a minimum of 30 seconds should be allowed before re-applying the power. A minimum of 5 minutes should be allowed before removing the terminal covers or connection.
- The maximum permissible short circuit current at the „VersiDrive i PRO“ Power terminals as defined in IEC60439-1 is 100kA.
- An optional Input Choke is recommended to be installed in the supply line for drives where any of the following conditions occur:-
 - The incoming supply impedance is low or the fault level / short circuit current is high
 - The supply is prone to dips or brown outs
 - An imbalance exists on the supply (3 phase drives)
 - The power supply to the drive is via a busbar and brush gear system (typically overhead Cranes).
- In all other installations, an input choke is recommended to ensure protection of the drive against power supply faults. Part numbers are shown in the table.

Supply	Frame Size	AC Input Inductor
230 Volt 1 Phase	2	On request
	3	On request
400 Volt 3 Phase	2	On request
	3	On request

4.4. Operation of 3 Phase drives from a Single Phase Supply

A special function of „VersiDrive i PRO“ allows all drives designed for operation on 3 phase supplies to be operated on a single phase supply of the correct rated voltage at up to 50% of the nominal capacity.

For Example, Model Number VD i 4500/3PRO can be operated on a single phase supply, 380 – 480 volts, with the maximum output current limited to 45 Amps

The supply should be connected to the L1 and L2 terminals of the drive.

4.5. Drive and Motor Connection

- The motor should be connected to the „VersiDrive i PRO“ U, V, and W terminals using a suitable 3 or 4 core cable. Where a 3 core cable is utilised, with the shield operating as an earth conductor, the shield must have a cross sectional area at least equal to the phase conductors when they are made from the same material. Where a 4 core cable is utilised, the earth conductor must be of at least equal cross sectional area and manufactured from the same material as the phase conductors.
- The motor earth must be connected to one of the „VersiDrive i PRO“ earth terminals.
- For compliance with the European EMC directive, a suitable screened (shielded) cable should be used. Braided or twisted type screened cable where the screen covers at least 85% of the cable surface area, designed with low impedance to HF signals are recommended as a minimum. Installation within a suitable steel or copper tube is generally also acceptable.
- The cable screen should be terminated at the motor end using an EMC type gland allowing connection to the motor body through the largest possible surface area
- Where drives are mounted in a steel control panel enclosure, the cable screen may be terminated directly to the control panel using a suitable EMC clamp or gland, as close to the drive as possible.
- For IP55 drives, connect the motor cable screen to the internal ground clamp

4.6. Motor Terminal Box Connections

Most general purpose motors are wound for operation on dual voltage supplies. This is indicated on the nameplate of the motor

This operational voltage is normally selected when installing the motor by selecting either STAR or DELTA connection. STAR always gives the higher of the two voltage ratings.

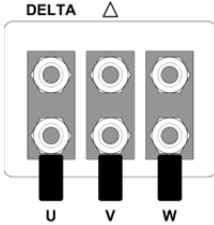
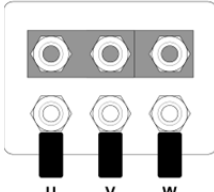
Incoming Supply Voltage	Motor Nameplate Voltages		Connection
230	230 / 400	Delta	
400	400 / 690		
400	230 / 400	Star	

4.7. Motor Thermal overload Protection.

4.7.1. Internal Thermal overload protection.

The drive has an in-built motor thermal overload function; this is in the form of an “I.t-trP” trip after delivering >100% of the value set in P1-08 for a sustained period of time (e.g. 150% for 60 seconds).

4.7.2. Motor Thermistor Connection

Where a motor thermistor is to be used, it should be connected as follows :-

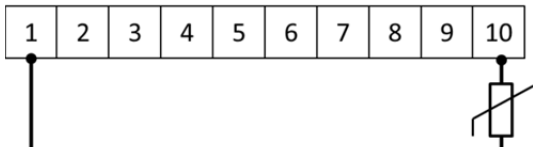
<p>Control Terminal Strip</p> 	<p>Additional Information</p> <ul style="list-style-type: none"> • Compatible Thermistor : PTC Type, 2.5kΩ trip level • Use a setting of P1-13 that has Input 5 function as External Trip, e.g. P1-13 = 6. Refer to section 7 for further details.
--	--

4.8. Control Terminal Wiring

- All analog signal cables should be suitably shielded. Twisted pair cables are recommended.
- Power and Control Signal cables should be routed separately where possible, and must not be routed parallel to each other
- Signal levels of different voltages e.g. 24 Volt DC and 110 Volt AC, should not be routed in the same cable.
- Maximum control terminal tightening torque is 0.5Nm
- Control Cable entry conductor size: 0.05 – 2.5mm² / 30 – 12 AWG.

4.9. Connection Diagrams

4.9.1. Power Terminal Designations

Incoming Mains Power Supply
 For 1 Phase Supply, connect to L1/L and L2/N terminals.
 For 3 Phase Supply, connect to L1, L2 & L3 terminals.
 Phase sequence is not important.

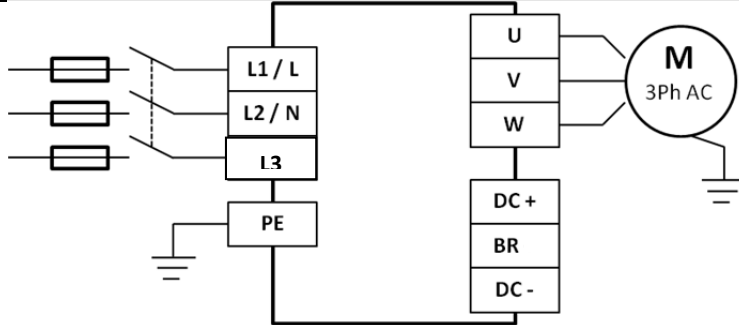

Motor Connections

Connect the motor to the U, V & W terminals.
 The motor earth must be connected to the drive

Optional Brake Resistor & DC Bus Connections

Where a Brake resistor is used, it must be connected to the BR and DC+ terminals

4.9.2. Control Terminal Connections & Factory Settings

	Open	Closed						
+24V Supply (100mA) / External Input	▶		+24V	1				
Digital Input 1	Stop	Run (Enable)	DIN1	2				
Digital Input 2	Forward Rotation	Reverse Rotation	DIN2	3				
Digital Input 3	Analog Speed Ref	Preset Speed	DIN3	4				
Digital Inputs : 8 – 30 Volt DC + 10 Volt, 10mA Output			+10V	5				
Analog Input 1			AIN1	6				
			0V	7	0V			
Analog Output : 0 – 10 Volt / 4-20mA, 20mA Max				8	AOUT1			Output Speed
0 Volt Supply / External Input			0V	9	0V			
Analog Input 2			AIN2	10				
Analog Output : 0 – 10 Volt / 4-20mA, 20mA Max				11	AOUT2			Output Current
External Hardware Enable Circuit			STO+	12				
			STO-	13				
Relay Contacts (Terminals 14-18) 250VAC / 30VDC 5A Maximum				14	RL1-C			Default Function : Healthy / Fault
				15	RL1-NO			
				16	RL1-NC			
				17	RL2-A			Default Function : Running
	18	RL2-B						

4.10. Control Terminal Connections

Main Terminal Strip			
1	+24V	+ 24V User Input / Output	100mA User Output
2	DI 1	Input 1	Digital 8 – 30 Volt DC
3	DI 2	Input 2	Digital 8 – 30 Volt DC
4	DI 3	Input 3	Digital 8 – 30 Volt DC
5	+10V	+ 10 Volt User Output	10mA for user potentiometer
6	AI 1	Input 4	Digital 8 to 30V DC / Analog Input 1, -10 to +10V, 0 / 4 to 20mA or +24VDC Digital
7	0V	0 Volt Common	
8	AO1	Output 1	1 st Analog / Digital Output, 0 to 10V, 4 to 20mA or +24VDC Digital
9	0V	0 Volt Common	
10	AI 2	Input 5	Digital 8 to 30V DC / Analog Input 2, 0 to 10V, 0 / 4 to 20mA or
11	AO2	Output 2	Analog Input 2 / Digital Output, 0 to 10V, 4 to 20mA, Digital 24V
12	STO+	Drive hardware inhibit	“Safe” 24V input - must be linked to ext +24 Volt (18 – 30 Volt) DC to enable power stage
13	STO-	Inhibit 0V input	0V return for the 24V “Safe” (STO)
Additional Terminal Strip			
14	RL1-C	Relay Output 1 Common	Relay contacts, 250V AC, 30V DC, 5A
15	RL1-NO	Relay Output 1 NO	Relay contacts, 250V AC, 30V DC, 5A
16	RL1-NC	Relay Output 1 NC	Relay contacts, 250V AC, 30V DC, 5A
17	RL2-A	Relay Output 2 Common	Relay contacts, 250V AC, 30V DC, 5A
18	RL2-B	Relay Output 2 NO	Relay contacts, 250V AC, 30V DC, 5A

4.11. Safe Torque Off

Safe Torque OFF will be referred to as “STO” through the remainder of this section.

4.11.1. Responsibilities

The overall system designer is responsible for defining the requirements of the overall “Safety Control System” within which the drive will be incorporated; furthermore the system designer is responsible for ensuring that the complete system is risk assessed and that the “Safety control System” requirements have been entirely met and that the function is fully verified, this must include confirmation testing of the “STO” function before drive commissioning.

The system designer shall determine the possible risks and hazards within the system by carrying out a thorough risk and hazard analysis, the outcome of the analysis should provide an estimate of the possible hazards, furthermore determine the risk levels and identify any needs for risk reduction. The “STO” function should be evaluated to ensure it can sufficiently meet the risk level required.

4.11.2. What STO Provides

The purpose of the “STO” function is to provide a method of preventing the drive from creating torque in the motor in the absence of the “STO” input signals (Terminal 12 with respect to Terminal 13), this allows the drive to be incorporated into a complete safety control system where “STO” requirements need to be fulfilled.¹

The “STO” function can typically eliminate the need for electro-mechanical contactors with cross-checking auxiliary contacts as per normally required to provide safety functions.²

The drive has the “STO” Function built-in as standard and complies with the definition of “Safe torque off” as defined by IEC 61800-5-2:2007.

The “STO” Function also corresponds to an uncontrolled stop in accordance with category 0 (Emergency Off), of IEC 60204-1. This means that the motor will coast to a stop when the “STO” function is activated, this method of stopping should be confirmed as being acceptable to the system the motor is driving.

The “STO” function is recognised as a fail safe method even in the case where the “STO” signal is absent and a single fault within the drive has occurred, the drive has been proven in respect of this by meeting the following safety standards :

	SIL (Safety Integrity Level)	PFH _D (Probability of dangerous Failures per Hour)	SFF (Safe failure fraction %)	Lifetime assumed
EN 61800-5-2	2	1.23E-09 1/h (0.12 % of SIL 2)	50	20 Yrs

	PL (Performance level)	CCF (%) (Common Cause Failure)
EN ISO 13849-1	PL d	1

	SILCL
EN 62061	SILCL 2

Note : The values achieved above maybe jeopardised if the drive is installed outside of the Environmental limits detailed in section 10.1.

4.11.3. What STO does not provide



Disconnect and ISOLATE the drive before attempting any work on it. The “STO” function does not prevent high voltages from being present at the drive power terminals.



¹ Note : The “STO” function does not prevent the drive from an unexpected re-start. As soon as the “STO” inputs receive the relevant signal it is possible (subject to parameter settings) to restart automatically, Based on this, the function should not be used for carrying out short-term non-electrical machinery operations (such as cleaning or maintenance work).



² Note : In some applications additional measures may be required to fulfil the systems safety function needs : the “STO” function does not provide motor braking. In the case where motor braking is required a time delay safety relay and/or a mechanical brake arrangement or similar method should be adopted, consideration should be made over the required safety function when braking as

the drive braking circuit alone cannot be relied upon as a fail safe method.



When using permanent magnet motors and in the unlikely event of a multiple output power devices failing then the motor could effectively rotate the motor shaft by 180/p degrees (Where p denotes number of motor pole pairs).

4.11.4. “STO” Operation

When the “STO” inputs are energised, the “STO” function is in a standby state, if the drive is then given a “Start signal/command” (as per the start source method selected in P1-13) then the drive will start and operate normally.

When the “STO” inputs are de-energised then the STO Function is activated and stops the drive (Motor will coast), the drive is now in “Safe Torque Off” mode.

To get the drive out of “Safe Torque Off” mode then any “Fault messages” need to be reset and the drive “STO” input needs to be re-energised.

4.11.5. “STO” Status and Monitoring

There are a number of methods for monitoring the status of the “STO” input, these are detailed below:

Drive Display

In Normal drive operation (Mains AC power applied), when the drives “STO” input is de-energised (“STO” Function activated) the drive will highlight this by displaying “InHibit”, (Note: If the drive is in a tripped condition then the relevant trip will be displayed and not “InHibit”).

Drive Output Relay

- Drive relay 1: Setting P2-15 to a value of “13” will result in relay opening when the “STO” function is activated.
- Drive relay 2: Setting P2-18 to a value of “13” will result in relay opening when the “STO” function is activated.

“STO” Fault Codes

Fault Code	Code Number	Description	Corrective Action
“Sto-F”	29	A fault has been detected within either of the internal channels of the “STO” circuit.	Refer to your PETER electronic Sales Partner

4.11.6. “STO” Function response time

The total response time is the time from a safety related event occurring to the components (sum of) within the system responding and becoming safe. (Stop Category 0 in accordance with IEC 60204-1)

- The response time from the “STO” inputs being de-energised to the output of the drive being in a state that will not produce torque in the motor (“STO” active) is less than 1ms.
- The response time from the “STO” inputs being de-energised to the “STO” monitoring status changing state is less than 20ms
- The response time from the drive sensing a fault in the STO circuit to the drive displaying the fault on the display/Digital output showing drive not healthy is less than 20ms.

4.11.7. “STO” Electrical Installation



The “STO” wiring shall be protected from inadvertent short circuits or tampering which could lead to failure of the “STO” input signal, further guidance is given in the diagrams below.

In addition to the wiring guidelines for the “STO” circuit below, section 4.1.1 should also be followed.

The drive should be wired as illustrated below; the 24Vdc signal source applied to the “STO” input can be either from the 24Vdc on the drive or from an External 24Vdc power supply.

4.11.7.1. Recommended “STO” wiring

Using an External 24Vdc Power Supply.

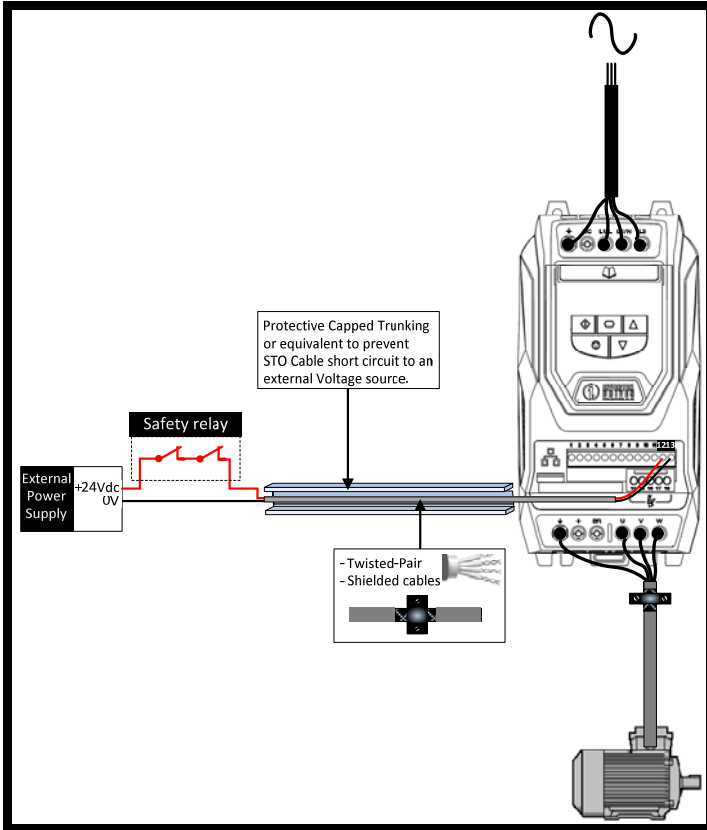

Using the drives on-board 24Vdc supply

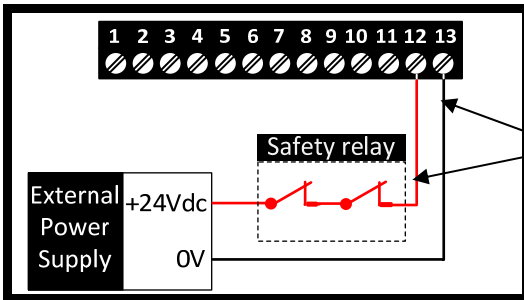
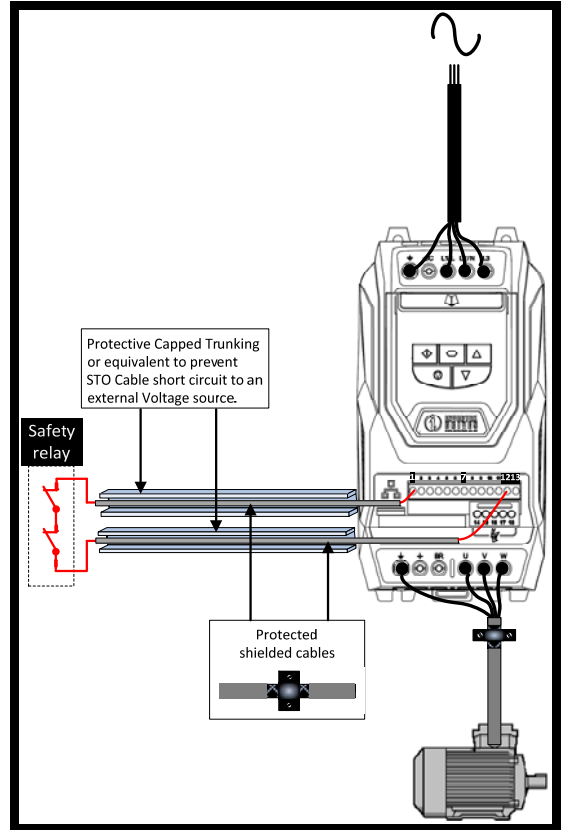

Wires should be protected against short circuits as shown above

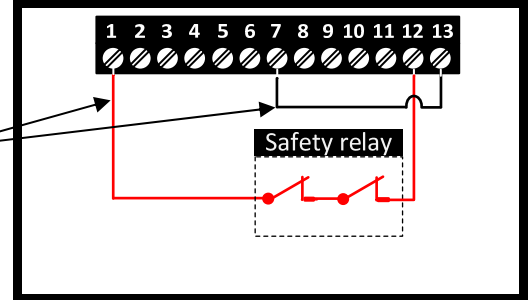

Note : The Maximum cable length from Voltage source to the drive terminals should not exceed 25 mtrs.

4.11.8. External Power supply Specification.

Voltage Rating (Nominal)	24Vdc
STO Logic High	18-30Vdc (Safe torque off in standby)
Current Consumption (Maximum)	100mA

4.11.9. Safety Relay Specification.

The safety relay should be chosen so that at minimum it meets the safety standards in which the drive meets.

Standard Requirements	SIL2 or PLd SC3 or better (With Forcibly guided Contacts)
Number of Output Contacts	2 independent
Switching Voltage Rating	30Vdc
Switching Current	100mA

4.11.10. Enabling the “STO” Function

The “STO” function is always enabled in the drive regardless of operating mode or parameter changes made by the user.

4.11.10.1. Testing the “STO” Function

Before commissioning the system the “STO” function should always be tested for correct operation, this should include the following tests:

- With the motor at standstill, and a stop command given to the drive (as per the start source method selected in P1-13):
 - De-energise the “STO” inputs (Drive will display “InHibit”).
 - Give a start command (as per the start source method selected in P1-13) and check that the drive still displays “Inhibit” and that the operation is in line with the section 4.11.4

- 4.11.4 and section 4.11.5

- With the motor running normally (from the drive):
 - De-energise the “STO” inputs
 - Check that the drive displays “InHibit” and that the motor stops *and* that the operation is in line with the section *and* section

4.11.10.2. “STO” Function Maintenance.

The “STO” function should be included within the control systems scheduled maintenance program so that the function is regularly tested for integrity (Minimum once per Year), furthermore the function should be integrity tested following any safety system modifications or maintenance work.

If drive fault messages are observed refer to section 11.1 for further guidance.

4.12. Connecting a Brake Resistor

VersiDrive i PRO units feature an internal brake transistor, fitted as standard for all frame Size 2 – 5 models, and optionally on larger frame sizes. The brake resistor should be connected to the DC+ and BR Terminals of the drive.

The brake transistor is enabled using P1-05 (Refer to section 8.1 for further information).





Software protection against brake resistor overload is carried out within the drive. For correct protection

- Set P1-14 = 201
- Enter the resistance of the brake resistor in P6-19 (Ohms)
- Enter the power of the brake resistor in P6-20 (kW)



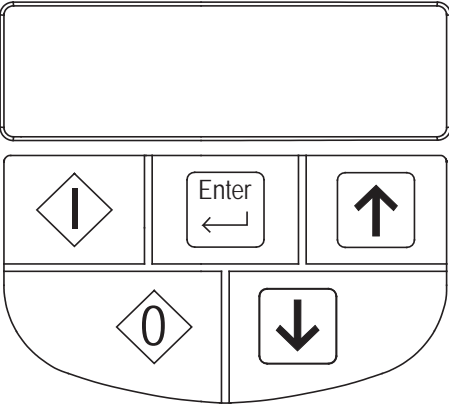





5. Managing the Keypad

The drive is configured and its operation monitored via the keypad and display.

5.1. Keypad Layout and Function

	NAVIGATE	Used to display real-time information, to access and exit parameter edit mode and to store parameter changes	
	UP	Used to increase speed in real-time mode or to increase parameter values in parameter edit mode	
	DOWN	Used to decrease speed in real-time mode or to decrease parameter values in parameter edit mode	
	RESET / STOP	Used to reset a tripped drive. When in Keypad mode is used to Stop a running drive.	
	START	When in keypad mode, used to Start a stopped drive or to reverse the direction of rotation if bi-directional keypad mode is enabled	

5.2. Changing Parameters

Procedure	Display shows...
Power on Drive	StoP
Press and hold the  for >2 seconds	P 1-01
Press the  Key	P 1-02
The  and  can be used to select the desired parameter	P 1-03 etc..
Select the required parameter, e.g. P1-02	P 1-02
Press the  button	0.0
Use  the  and keys to adjust the value, e.g. set to 10	10.0
Press the  key	P 1-02
The parameter value is now adjusted and automatically stored. Press the  key for >2 seconds to return to operating mode	StoP

5.3. Advanced Keypad Operation Short Cuts





Function	When Display shows...	Press...	Result	Example
Fast Selection of Parameter Groups Note : Parameter Group Access must be enabled P1-14 = 101	P_{x-xx}		The next highest Parameter group is selected	Display shows $P 1-10$ Press Display shows $P 2-01$
	P_{x-xx}		The next lowest Parameter group is selected	Display shows $P 2-26$ Press Display shows $P 1-01$
Select lowest Group Parameter	P_{x-xx}		The first parameter of a group is selected	Display shows $P 1-10$ Press Display shows $P 1-01$
Set Parameter to minimum value	Any numerical value (Whilst editing a parameter value)		The parameter is set to the minimum value	When editing P1-01 Display shows 50.0 Press Display shows 0.0
Adjusting individual digits within a parameter value	Any numerical value (Whilst editing a parameter value)		Individual parameter digits can be adjusted	When editing P1-10 Display shows 0 Press Display shows -0 Press Display shows 10 Press Display shows -10 Press Display shows 110 Etc...

5.4. Drive Operating Displays

Display	Status	
$StoP$	Drive mains power applied, but no Enable or Run signal applied	
$Autot$	Motor Autotune in progress.	
$H x.x$	Drive running, display shows output frequency (Hz)	Whilst the drive is running, the following displays can be selected by briefly pressing the button on the drive. Each press of the button will cycle the display through to the next selection.
$A x.x$	Drive running, display shows motor current (Amps)	
$P x.x$	Drive Running, display shows motor power (kW)	
$C x.x$	Drive Running, display shows customer selected units, see parameters P2-21 and P2-22	
$E24-24$	Drive mains power not present, external 24 Volt control power supply present only	
$Inhibt$	Output power hardware inhibited, Safe Torque Off function activated. External links are required to the STO inputs (terminals 12 and 13) as shown in section 4.9.	
$P-dEF$	Parameters reset to factory default settings	
$U-dEF$	Parameters reset to User default settings	

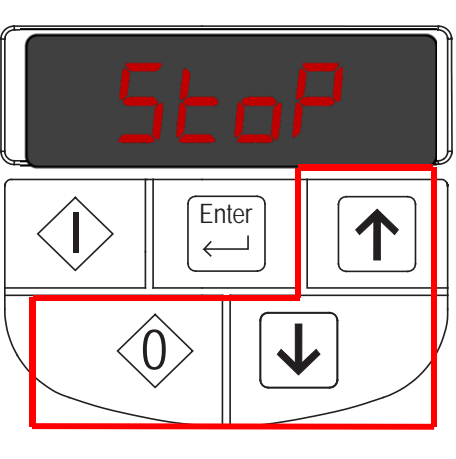

For drive fault code displays, refer to section 11.1 on page 50.

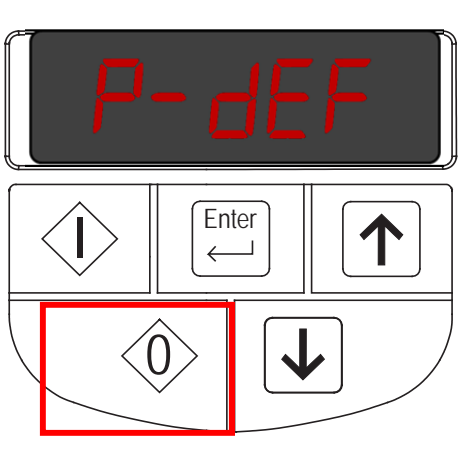
5.5. Resetting Parameters to Factory Default Settings

	<p>Press and hold the    Keys for at least 2 seconds The display will show <i>P-dEF</i> Press the key</p>	
--	---	---















5.6. Terminal Control

When delivered, the „VersiDrive i PRO“ is in the factory default state, meaning that it is set to operate in terminal control mode and all parameters have the default values as indicated in section 6.

- Connect the drive to the supply, ensuring the correct voltage and fusing / circuit breaker protection – see section 10.2.
- Connect the motor to the drive, ensuring the correct star/delta connection for the voltage rating - see section 4.6.
- Apply the mains power to the drive, then enter the motor data from motor nameplate; P1-07 = motor rated voltage, P1-08 = motor rated current, P1-09 = motor rated frequency.
- Connect the Drive Hardware Inhibit (STO) circuit as follows (see section 4.9 and 4.11 for further details)
 - Link Terminal 1 to Terminals 12 (STO +)
 - Link Terminal 9 to Terminal 13 (STO -)
- Connect a control switch between the control terminals 1 and 2 ensuring that the contact is open (drive disabled).
- Connect a potentiometer (1kΩ min to 10 kΩ max) between terminals 5 and 7, and the wiper to terminal 6.
- With the potentiometer set to zero, switch on the supply to the drive. The display will show *StoP*.
- Close the control switch, terminals 1-2. The drive is now ‘enabled’ and the output frequency/speed are controlled by the potentiometer. The display shows zero speed in Hz (*H 0.0*) with the potentiometer turned to minimum.
- Turn the potentiometer to maximum. The motor will accelerate to 50Hz, (60Hz for HP drives), the default value of P1-01, under the control of the acceleration ramp time P1-03.
- If the potentiometer is turned to minimum, the motor will decelerate to 0Hz, the default minimum speed set in P1-02, under the control of the deceleration ramp P1-04. The output speed can be adjusted anywhere between minimum and maximum speed using the potentiometer.
- To display motor current (Amps), briefly press the  (Navigate) key.
- Press  again to display the motor power.
- Press  again to return to speed display.
- To stop the motor, disable the drive by opening the control switch (terminals 1-2).
- If the enable/disable switch is opened the drive will decelerate to stop at which time the display will show *StoP*.

5.7. Keypad Control

To allow the „VersiDrive i PRO“ to be controlled from the keypad in a forward direction only, set P1-12 =1:

- Connect the drive to the supply, ensuring the correct voltage and fusing / circuit breaker protection – see section 10.2.
- Connect the motor to the drive, ensuring the correct star/delta connection for the voltage rating - see section 4.6.
- Apply the mains power to the drive, then enter the motor data from motor nameplate; P1-07 = motor rated voltage, P1-08 = motor rated current, P1-09 = motor rated frequency.
- Connect the Drive Hardware Inhibit (STO) circuit as follows
 - Link Terminal 1 to Terminals 12 (STO +)
 - Link Terminal 9 to Terminal 13 (STO -)
- Connect a control switch between the control terminals 1 and 2 ensuring that the contact is open (drive disabled).
- Enable the drive by closing the switch between control terminals 1 & 2. The display will show **StoP**.
- Press the  key. The display shows **H 0.0**.
- Press  to increase speed.
- The drive will run forward, increasing speed until  is released.
- Press  to decrease speed. The drive will decrease speed until  is released. The rate of deceleration is limited by the setting in P1-04
- Press the  key. The drive will decelerate to rest at the rate set in P1-04.
- The display will finally show **StoP** at which point the drive is disabled
- To preset a target speed prior to enable, press the  key whilst the drive is stopped. The display will show the target speed, use the  &  keys to adjust as required then press the  key to return the display to **StoP**.
- Pressing the  key will start the drive accelerating to the target speed.
- To allow the „VersiDrive i PRO“ to be controlled from the keypad in a forward and reverse direction, set P1-12 =2:
- Operation is the same as when P1-12=1 for start, stop and changing speed.
- Press the  key. The display changes to **H 0.0**.
- Press  to increase speed
- The drive will run forward, increasing speed until  is released. Acceleration is limited by the setting in P1-03. The maximum speed is the speed set in P1-01.
- To reverse the direction of rotation of the motor, press the  key again.

5.8. Operating in Sensorless Vector Speed Control Mode

„VersiDrive i PRO“ can be programmed by the user to operate in Sensorless Vector mode, which provides enhanced low speed torque, optimum motor speed regulation regardless of load and accurate control of the motor torque. In most applications, the default Voltage Vector control mode will provide adequate performance, however if Sensorless Vector operation is required, use the following procedure.

- Ensure advanced parameter access is enabled by setting P1-14 = 101
- Enter the motor nameplate details into the relevant parameters as follows
 - P1-07 Motor Rated Voltage
 - P1-08 Motor Rated Current
 - P1-09 Motor Rated Frequency
 - (Optional) P1-10 Motor Rated Speed (Rpm)
 - P4-05 Motor Power Factor
- Select Sensorless Vector control mode by setting P4-01 = 0
- Ensure that the motor is correctly connected to the drive
- Carry out a motor data Autotune by setting P4-02 = 1



The Autotune will begin immediately when P4-02 is set regardless of the status of the drive enable signal. Whilst the autotune procedure does not drive or spin the motor, the motor shaft may still turn slightly. It is not normally necessary to uncouple the load from the motor; however the user should ensure that no risk arises from the possible movement of the motor shaft.

It is essential that the correct motor data is entered into the relevant drive parameters. Incorrect parameter settings can result in poor or even dangerous performance.

6. Parameters

6.1. Parameter Set Overview

The VersiDrive i PRO Parameter set consists of 6 groups as follows:

- Group 0 – Read Only Monitoring Parameters
- Group 1 – Basic Configuration Parameters
- Group 2 – Extended Parameters
- Group 3 – PID Control Parameters
- Group 4 – High Performance Motor Control Parameters
- Group 5 –Field Bus Parameters

When the VersiDrive i PRO drive is reset to factory defaults, or is in its factory supplied state, only Group 1 Parameters can be accessed. In order to allow access to parameters from the higher level groups, P1-14 must be set to the same value as P2-40 (Default setting = 101). With this setting, parameter groups 1 – 5 can be accessed, along with the first 38 parameters in Group 0.

6.2. Parameter Group 1 – Basic Parameters

Par	Parameter Name	Minimum	Maximum	Default	Units
P1-01	Maximum Frequency / Speed Limit	P1-02	500.0	50.0 (60.0)	Hz / Rpm
	Maximum output frequency or motor speed limit – Hz or rpm. If P1-10 >0, the value entered / displayed is in Rpm				
P1-02	Minimum Frequency / Speed Limit	0.0	P1-01	0.0	Hz / Rpm
	Minimum speed limit – Hz or rpm. If P1-10 >0, the value entered / displayed is in Rpm				
P1-03	Acceleration Ramp Time	See Below		5.0 / 10.0	Seconds
	Acceleration ramp time from 0 to base speed (P-1-09) in seconds. FS2 & FS3 : 5.0 Seconds Default Setting, 0.01 Seconds Resolution, 600.0 Seconds Maximum FS4 – FS7 : 10.0 Seconds Default Setting, 0.1 Seconds Resolution, 6000 Seconds Maximum				
P1-04	Deceleration Ramp Time	See Below		5.0 / 10.0	Seconds
	Deceleration ramp time from base speed (P1-09) to standstill in seconds. When set to zero, fastest possible ramp time without trip is activated FS2 & FS3 : 5.0 Seconds Default Setting, 0.01 Seconds Resolution, 600.0 Seconds Maximum FS4 – FS7 : 10.0 Seconds Default Setting, 0.1 Seconds Resolution, 6000.0 Seconds Maximum				
P1-05	Stop Mode	0	3	0	-
	<p>0 : Ramp To Stop. When the enable signal is removed, the drive will ramp to stop, with the rate controlled by P1-04 as described above. In this mode, the drive brake transistor (where fitted) is disabled.</p> <p>1 : Coast to Stop. When the enable signal is removed, the drive output is immediately disabled, and the motor will coast (freewheel) to stop. If the load can continue to rotate due to inertia, and the drive may possibly be re-enabled whilst the motor is still rotating, the spin start function (P2-26) should be enabled. In this mode, the drive brake transistor (where fitted) is disabled.</p> <p>2 : Ramp To Stop. When the enable signal is removed, the drive will ramp to stop, with the rate controlled by P1-04 as described above. The VersiDrive i PRO Brake chopper is also enabled in this mode.</p> <p>3 : Coast to Stop. When the enable signal is removed, the drive output is immediately disabled, and the motor will coast (freewheel) to stop. If the load can continue to rotate due to inertia, and the drive may possibly be re-enabled whilst the motor is still rotating, the spin start function (P2-26) should be enabled. The drive brake chopper is enabled in this mode, however it will only activate when required during a change in the drive frequency setpoint, and will not activate when stopping.</p>				
P1-06	Energy Optimiser	0	1	0	-
	<p>Only active when enhanced V/F motor control mode is selected (P4-01 = 2).</p> <p>0 : Disabled</p> <p>1 : Enabled. When enabled, the Energy Optimiser attempts to reduce the overall energy consumed by the drive and motor when operating at constant speeds and light loads. The output voltage applied to the motor is reduced. The Energy Optimiser is intended for applications where the drive may operate for some periods of time with constant speed and light motor load, whether constant or variable torque.</p>				
P1-07	Motor Rated Voltage	Drive Rating Dependent			Volts
	This parameter should be set to the rated (nameplate) voltage of the motor (Volts)				
P1-08	Motor Rated Current	Drive Rating Dependent			Amps
	This parameter should be set to the rated (nameplate) current of the motor				
P1-09	Motor Rated Frequency	10	500	50 (60)	Hz
	This parameter should be set to the rated (nameplate) frequency of the motor				
P1-10	Motor Rated Speed	0	30000	0	Rpm
	<p>This parameter can optionally be set to the rated (nameplate) rpm of the motor. When set to the default value of zero, all speed related parameters are displayed in Hz, and the slip compensation for the motor is disabled. Entering the value from the motor nameplate enables the slip compensation function, and the VersiDrive i PRO display will now show motor speed in estimated rpm. All speed related parameters, such as Minimum and Maximum Speed, Preset Speeds etc. will also be displayed in Rpm.</p> <p>Note : When the drive is operated with the optional Encoder Feedback Interface, this parameter must be set to the correct nameplate Rpm of the connected motor.</p>				

P1-11	V/F Mode Voltage Boost	0.0	Drive Rating Dependent	%	
	<p>Voltage boost is used to increase the applied motor voltage at low output frequencies, in order to improve low speed and starting torque. Excessive voltage boost levels may result in increased motor current and temperature, and force ventilation of the motor may be required.</p> <p>An automatic setting (Auto) is also possible, whereby the VersiDrive i PRO will automatically adjust this parameter based on the motor parameters measured during an autotune.</p>				
P1-12	Primary Command Source Mode	0	6	0	-
	<p>0: Terminal Control. The drive responds directly to signals applied to the control terminals.</p> <p>1: Uni-directional Keypad Control. The drive can be controlled in the forward direction only using an external or remote Keypad</p> <p>2: Bi-directional Keypad Control. The drive can be controlled in the forward and reverse directions using an external or remote Keypad. Pressing the keypad START button toggles between forward and reverse.</p> <p>3: PID Control. The output frequency is controlled by the internal PID controller.</p> <p>4: Fieldbus Control. Control via Modbus RTU if no fieldbus interface option is present, otherwise control is from the fieldbus option module interface</p> <p>5: Slave Mode. The drive acts as a Slave to a connected VersiDrive i PRO drive operating in Master Mode</p> <p>6 : CAN bus Control. Control via CAN bus connected to the RJ45 serial interface connector</p>				
P1-13	Digital Inputs Function Select	0	21	1	-
	<p>Defines the function of the digital inputs depending on the control mode setting in P1-12. See section 7.1 for more information.</p>				
P1-14	Extended Menu Access Code	0	30000	0	-
	<p>Parameter Access Control. The following settings are applicable :</p> <p>P1-14 = P2-40 = 101 : Allows access to Extended Parameter Groups 0 – 5</p> <p>P1-14 = P6-30 = 201 = Allows access to all parameter groups (Intended for experienced users only, usage is not described in this User Guide)</p>				

7. Digital Input Functions

7.1. Digital Input Configuration Parameter P1-13

P1-13	Digital Input 1 (Terminal 2)	Digital Input 2 (Terminal 3)	Digital Input 3 (Terminal 4)	Analog Input 1 (Terminal 6)	Analog Input 2 (Terminal 10)	
0	User defined	User defined	User defined	User defined	User defined	
1	O: Stop C: Run	O: Forward C: Reverse	O: Selected Speed Ref C: Preset speed 1, 2	Analog 1 Speed reference	O: Preset speed 1 C: Preset speed 2	
2	O: Stop C: Run	O: Forward C: Reverse	Digital input 3	Analog input 1	Analog input 2	Preset Speed
			Off	Off	Off	Preset Speed 1
			On	Off	Off	Preset Speed 2
			Off	On	Off	Preset Speed 3
			On	On	Off	Preset Speed 4
			Off	Off	On	Preset Speed 5
			On	Off	On	Preset Speed 6
			Off	On	On	Preset Speed 7
On	On	On	Preset Speed 8			
3	O: Stop C: Run	O: Forward C: Reverse	O: Selected Speed Ref C: Preset speed 1	Analog 1 Speed reference	Analog torque reference	
4	O: Stop C: Run	O: Forward C: Reverse	O: Selected Speed Ref C: Preset speed 1	Analog 1 Speed reference	O: Decel ramp 1 (P1-04) C: Decel ramp 2 (P8-11) ¹⁾	
5	O: Stop C: Run	O: Forward C: Reverse	O: Selected Speed Ref C: Analog input 2	Analog 1 Speed reference	Analog 2 Speed reference	
6	O: Stop C: Run	O: Forward C: Reverse	O: Selected Speed Ref C: Preset speed 1	Analog 1 Speed reference	External trip ²⁾ O: trip C: Run	
7	O: Stop C: Run	O: Forward C: Reverse	Digital input 3	Analog input 1	Preset Speed	External trip ²⁾ O: trip C: Run
			Off	Off	Preset Speed 1	
			On	Off	Preset Speed 2	
			Off	On	Preset Speed 3	
8	O: Stop C: Run	O: Forward C: Reverse	Digital input 3	Analog input 1	Preset Speed	O: Decel ramp 1 (P1-04) C: Decel ramp 2 (P2-25)
			Off	Off	Preset Speed 1	
			On	Off	Preset Speed 2	
			Off	On	Preset Speed 3	
9	O: Stop C: Run	O: Forward C: Reverse	Digital input 3	Analog input 1	Preset Speed	O: Selected Speed Ref C: Preset speed 1 .. 4
			Off	Off	Preset Speed 1	
			On	Off	Preset Speed 2	
			Off	On	Preset Speed 3	
10	O: Stop C: Run	O: Forward C: Reverse	Normally Open (N.O.) Close to increase speed	Normally Open (N.O.) Close to reduce speed		O: Selected Speed Ref C: Preset speed 1

P1-13	Digital Input 1 (Terminal 2)	Digital Input 2 (Terminal 3)	Digital Input 3 (Terminal 4)	Analog Input 1 (Terminal 6)	Analog Input 2 (Terminal 10)	
11	O: Stop C: Run Fwd	O: Stop C: Run Rev	O: Selected Speed Ref C: Preset speed 1, 2	Analog 1 Speed reference	O: Preset speed 1 C: Preset speed 2	
12	O: Stop C: Run Fwd	O: Stop C: Run Rev	Digital input 3	Analog input 1	Analog input 2	Preset Speed
			Off	Off	Off	Preset Speed 1
			On	Off	Off	Preset Speed 2
			Off	On	Off	Preset Speed 3
			On	On	Off	Preset Speed 4
			Off	Off	On	Preset Speed 5
			On	Off	On	Preset Speed 6
			Off	On	On	Preset Speed 7
On	On	On	Preset Speed 8			
13	O: Stop C: Run Fwd	O: Stop C: Run Rev	O: Selected Speed Ref C: Preset speed 1	Analog 1 Speed reference	Analog torque reference	
14	O: Stop C: Run Fwd	O: Stop C: Run Rev	O: Selected Speed Ref C: Preset speed 1	Analog 1 Speed reference	O: Decel ramp 1 (P1-04) C: Decel ramp 2 (P8-11) ¹⁾	
15	O: Stop C: Run Fwd	O: Stop C: Run Rev	O: Selected Speed Ref C: Analog input 2	Analog 1 Speed reference	Analog 2 Speed reference	
16	O: Stop C: Run Fwd	O: Stop C: Run Rev	O: Selected Speed Ref C: Preset speed 1	Analog 1 Speed reference	External trip ²⁾ O: trip C: Run	
17	O: Stop C: Run Fwd	O: Stop C: Run Rev	Digital input 3	Analog input 1	Preset Speed	External trip ²⁾ O: trip C: Run
			Off	Off	Preset Speed 1	
			On	Off	Preset Speed 2	
			Off	On	Preset Speed 3	
18	O: Stop C: Run Fwd	O: Stop C: Run Rev	Digital input 3	Analog input 1	Preset Speed	O: Decel ramp 1 (P1-04) C: Decel ramp 2 (P2-25)
			Off	Off	Preset Speed 1	
			On	Off	Preset Speed 2	
			Off	On	Preset Speed 3	
19	O: Stop C: Run Fwd	O: Stop C: Run Rev	Digital input 3	Analog input 1	Preset Speed	O: Selected Speed Ref C: Preset speed 1 .. 4
			Off	Off	Preset Speed 1	
			On	Off	Preset Speed 2	
			Off	On	Preset Speed 3	
20	O: Stop C: Run Fwd	O: Stop C: Run Rev	Normally Open (N.O.) Close to increase speed	Normally Open (N.O.) Close to reduce speed	O: Selected Speed Ref C: Preset speed 1	
			21	Normally Open (N.O.) Close to run Fwd	Normally Closed (N.C.) Open to Stop	Normally Open (N.O.) Close to run Rev

The "Selected Speed Reference" referred to in the above table is determined by the value set in P1-12 (Control Mode) :

P1-12 (control Mode)	Selected Speed Reference
0 : Terminal Mode	Analog input 1
1 : Keypad Mode (uni-directional)	Digital Potentiometer
2 : Keypad Mode (bi-directional)	Digital Potentiometer
3 : User PID mode	PID controller output
4 : Fieldbus Control	Speed reference via Fieldbus
5 : Slave Mode	Speed reference via Optibus

Note

- 1) To access P8-11, set P1-14 = 201
- 2) If a motor thermistor (PTC type only, or normally closed thermal switch contact) is to be connected, this must be selected in P2-33. Connect the thermistor between terminal 1 and terminal 10.
- 3) When P1-12 = 0 and P 1-13 = 10 or 20, the Motorised Pot / Keypad reference is automatically selected to be the Selected Speed Reference

8. Extended Parameters

8.1. Parameter Group 2 - Extended parameters

Par	Parameter Name	Minimum	Maximum	Default	Units
P2-01	Preset / Jog Frequency / Speed 1	P1-02	P1-01	5.0	Hz / Rpm
P2-02	Preset / Jog Frequency / Speed 2	P1-02	P1-01	10.0	Hz / Rpm
P2-03	Preset / Jog Frequency / Speed 3	P1-02	P1-01	25.0	Hz / Rpm
P2-04	Preset / Jog Frequency / Speed 4	P1-02	P1-01	50.0 (60.0)	Hz / Rpm
P2-05	Preset / Jog Frequency / Speed 5	P1-02	P1-01	0.0	Hz / Rpm
P2-06	Preset / Jog Frequency / Speed 6	P1-02	P1-01	0.0	Hz / Rpm
P2-07	Preset / Jog Frequency / Speed 7	P1-02	P1-01	0.0	Hz / Rpm
P2-08	Preset / Jog Frequency / Speed 8	P1-02	P1-01	0.0	Hz / Rpm
Preset Speeds / Frequencies selected by digital inputs depending on the setting of P1-13. If P1-10 = 0, the values are entered as Hz. If P1-10 > 0, the values are entered as Rpm. Setting a negative value will reverse the direction of motor rotation.					
P2-09	Skip Frequency Centre Point	P1-02	P1-01	0.0	Hz / Rpm
P2-10	Skip Frequency Band Width	0.0	P1-01	0.0	Hz / Rpm
The Skip Frequency function is used to avoid the VersiDrive i PRO operating at a certain output frequency, for example at a frequency which causes mechanical resonance in a particular machine. Parameter P2-09 defines the centre point of the skip frequency band, and is used conjunction with P2-10. The VersiDrive i PRO output frequency will ramp through the defined band at the rates set in P1-03 and P1-04 respectively, and will not hold any output frequency within the defined band. If the frequency reference applied to the drive is within the band, the VersiDrive i PRO output frequency will remain at the upper or lower limit of the band.					
P2-11	Analog Output 1 (Terminal 8) Function Select	0	11	8	-
Digital Output Mode. Logic 1 = +24V DC					
0 : Drive Enabled (Running). Logic 1 when the VersiDrive i PRO is enabled (Running) 1 : Drive Healthy. Logic 1 When no Fault condition exists on the drive 2 : At Target Frequency (Speed). Logic 1 when the output frequency matches the setpoint frequency 3 : Output Frequency > 0.0. Logic 1 when the motor runs above zero speed 4 : Output Frequency >= Limit. Logic 1 when the motor speed exceeds the adjustable limit 5 : Output Current >= Limit. Logic 1 when the motor current exceeds the adjustable limit 6 : Motor Torque >= Limit. Logic when the motor torque exceeds the adjustable limit 7 : Analog Input 2 Signal Level >= Limit. Logic when the signal applied to the Analog Input 2 exceeds the adjustable limit Note : When using settings 4 – 7, parameters P2-16 and P2-17 must be used together to control the behaviour. The output will switch to Logic 1 when the selected signal exceeds the value programmed in P2-16, and return to Logic 0 when the signal falls below the value programmed in P2-17.					
Analog Output Mode					
8 : Output Frequency (Motor Speed). 0 to P-01 9 : Output (Motor) Current. 0 to 200% of P1-08 10 : Motor Torque. 0 to 200% of motor rated torque 11 : Output (Motor) Power. 0 to 150% of drive rated power 12 : PID Output. Output from the internal PID Controller, 0 – 100%					
P2-12	Analog Output 1 (Terminal 8) Format	See Below		U 0-10	-
U 0-10 = 0 to 10V. U 10-0 = 10 to 0V, A 0-20 = 0 to 20mA A 20-0 = 20 to 0mA A 4-20 = 4 to 20mA A 20-4 = 20 to 4mA					
P2-13	Analog Output 2 (Terminal 11) Function Select	0	11	9	-
Digital Output Mode. Logic 1 = +24V DC					
0 : Drive Enabled (Running). Logic 1 when the VersiDrive i PRO is enabled (Running) 1 : Drive Healthy. Logic 1 When no Fault condition exists on the drive 2 : At Target Frequency (Speed). Logic 1 when the output frequency matches the setpoint frequency 3 : Output Frequency > 0.0. Logic 1 when the motor runs above zero speed 4 : Output Frequency >= Limit. Logic 1 when the motor speed exceeds the adjustable limit 5 : Output Current >= Limit. Logic 1 when the motor current exceeds the adjustable limit 6 : Output Torque >= Limit. Logic when the motor torque exceeds the adjustable limit 7 : Analog Input 2 Signal Level >= Limit. Logic when the signal applied to the Analog Input 2 exceeds the adjustable limit Note : When using settings 4 – 7, parameters P2-16 and P2-17 must be used together to control the behaviour. The output will switch to Logic 1 when the selected signal exceeds the value programmed in P2-16, and return to Logic 0 when the signal falls below the value programmed in P2-17.					
Analog Output Mode					
8 : Output Frequency (Motor Speed). 0 to P-01 9 : Output (Motor) Current. 0 to 200% of P1-08 10 : Motor Torque. 0 to 200% of motor rated torque					

Par	Parameter Name	Minimum	Maximum	Default	Units
	11 : Output (Motor) Power. 0 to 150% of drive rated power 12 : PID Output. Output from the internal PID Controller, 0 – 100%				
P2-14	Analog Output 2 (Terminal 11) Format	See Below		U 0- 10	-
	U 0- 10 = 0 to10V. U 10-0 = 10 to 0V, A 0-20 = 0 to 20mA A 20-0 = 20to 0mA A 4-20 = 4 to 20mA A 20-4 = 20 to 4mA				
P2-15	User Relay 1 Output (Terminals 14, 15 & 16) Function select	0	7	1	-
	Selects the function assigned to Relay Output 1. The relay has three output terminals, Logic 1 indicates the relay is active, and therefore terminals 14 and 15 will be linked together. 0 : Drive Enabled (Running). Logic 1 when the motor is enabled 1: Drive Healthy. Logic 1 when power is applied to the drive and no fault exists 2 : At Target Frequency (Speed). Logic 1 when the output frequency matches the setpoint frequency 3: Output Frequency > 0.0 Hz. Logic 1 when the drive output frequency to the motor is exceeds 0.0Hz 4 : Output Frequency >= Limit. Logic 1 when the motor speed exceeds the adjustable limit 5 : Output Current >= Limit. Logic 1 when the motor current exceeds the adjustable limit 6 : Output Torque >= Limit. Logic 1 when the motor torque exceeds the adjustable limit 7 : Analog Input 2 Signal Level >= Limit. 1 Logic when the signal applied to the Analog Input 2 exceeds the adjustable limit Note : When using settings 4 – 7, parameters P2-16 and P2-17 must be used together to control the behaviour. The output will switch to Logic 1 when the selected signal exceeds the value programmed in P2-16, and return to Logic 0 when the signal falls below the value programmed in P2-17. 8 : Reserved. No Function 9 : Reserved. No Function 10 : Reserved. No Function 11 : Reserved. No Function 12 : Drive Tripped. Logic one when the drive has tripped and the display shows the fault code. 13 : STO Status. Logic 1 when both STO inputs are present and the drive is able to be operated 14 : PID Error >= Limit. The PID Error (difference between setpoint and feedback) is greater than or equal to the programmed limit				
P2-16	Adjustable Threshold 1 Upper Limit (Analog Output 1 / Relay Output 1)	P2-17	200.0	100.0	%
P2-17	Adjustable Threshold 1 Lower Limit (Analog Output 1 / Relay Output 1)	0.0	P2-16	0.0	%
	Used in conjunction with some settings of Parameters P2-11 & P2-15.				
P2-18	User Relay 2 Output (Terminals 17 & 18) Function select	0	8	0	-
	Selects the function assigned to Relay Output 2. The relay has two output terminals, Logic 1 indicates the relay is active, and therefore terminals 17 and 18 will be linked together. 0 : Drive Enabled (Running). Logic 1 when the motor is enabled 1: Drive Healthy. Logic 1 when power is applied to the drive and no fault exists 2 : At Target Frequency (Speed). Logic 1 when the output frequency matches the setpoint frequency 3: Output Frequency > 0.0 Hz. Logic 1 when the drive output frequency to the motor is exceeds 0.0Hz 4 : Output Frequency >= Limit. Logic 1 when the motor speed exceeds the adjustable limit 5 : Output Current >= Limit. Logic 1 when the motor current exceeds the adjustable limit 6 : Output Torque >= Limit. Logic 1 when the motor torque exceeds the adjustable limit 7 : Analog Input 2 Signal Level >= Limit. 1 Logic when the signal applied to the Analog Input 2 exceeds the adjustable limit 8 : Hoist Brake Control. The relay can be used to control the motor holding brake on a hoist. Contact your local PETER electronic Sales Partner for further information on using this feature. Note : When using settings 4 – 7, parameters P2-19 and P2-20 must be used together to control the behaviour. The output will switch to Logic 1 when the selected signal exceeds the value programmed in P2-19, and return to Logic 0 when the signal falls below the value programmed in P2-20. 9 : Reserved. No Function 10 : Reserved. No Function 11 : Reserved. No Function 12 : Drive Tripped. Logic one when the drive has tripped and the display shows the fault code. 13 : STO Status. Logic 1 when both STO inputs are present and the drive is able to be operated 14 : PID Error >= Limit. The PID Error (difference between setpoint and feedback) is greater than or equal to the programmed limit				
P2-19	Adjustable Threshold 1 Upper Limit (Analog Output 2 / Relay Output 2)	P2-20	200.0	100.0	%
P2-20	Adjustable Threshold 1 Lower Limit (Analog Output 2 / Relay Output 2)	0.0	P2-19	0.0	%
	Used in conjunction with some settings of Parameters P2-13 & P2-18.				
P2-21	Display Scaling Factor	-30.000	30.000	0.000	-
P2-22	Display Scaling Source	0	2	0	-
	P2-21 & P2-22 allow the user to program the VersiDrive i PRO to display an alternative output unit scaled from an existing parameter, e.g. to display conveyer speed in metres per second based on the output frequency. This function is disabled if P2-21 is set to 0. If P2-21 is set >0, the variable selected in P2-22 is multiplied by the factor entered in P2-21, and displayed whilst the drive is running, with a 'c' to indicate the customer scaled units. P2-22 Options				

Par	Parameter Name	Minimum	Maximum	Default	Units
	0: Motor Speed 1: Motor Current 2: Analog Input 2 3: P0-80 Value				
P2-23	Zero Speed Holding Time Determines the time for which the drive output frequency is held at zero when stopping, before the drive output is disabled	0.0	60.0	0.2	Seconds
P2-24	Effective Switching Frequency Effective power stage switching frequency. The range of settings available and factory default parameter setting depend on the drive power and voltage rating. Higher frequencies reduce the audible 'ringing' noise from the motor, and improve the output current waveform, at the expense of increased drive losses. Refer to section 0 for further information regarding operation at higher switching frequency.	Drive Rating Dependent			kHz
P2-25	2nd Deceleration Ramp Time This parameter allows an alternative deceleration ramp down time to be programmed into the VersiDrive i PRO, which can be selected by digital inputs (dependent on the setting of P1-13) or selected automatically in the case of a mains power loss if P2-38 = 2. When set to 0.0, the drive will coast to stop.	0.00	240.0	0.00	Seconds
P2-26	Spin Start Enable 0 : Disabled 1 : Enabled. When enabled, on start up the drive will attempt to determine if the motor is already rotating, and will begin to control the motor from its current speed. A short delay may be observed when starting motors which are not turning.	0	1	0	-
P2-27	Standby Mode Timer This parameter defines time period, whereby if the drive operates at minimum speed for at least the set time period, the VersiDrive i PRO output will be disabled, and the display will show Stndby . The function is disabled if P2-27 = 0.0.	0.0	250.0	0.0	Seconds
P2-28	Slave Speed Scaling Control Active in Keypad mode (P1-12 = 1 or 2) and Slave mode (P1-12=5) only. The keypad reference can be multiplied by a preset scaling factor or adjusted using an analog trim or offset. 0 : Disabled. No scaling or offset is applied. 1 : Actual Speed = Digital Speed x P2-29 2 : Actual Speed = (Digital Speed x P2-29) + Analog Input 1 Reference 3 : Actual Speed = (Digital Speed x P2-29) x Analog Input 1 Reference	0	3	0	-
P2-29	Slave Speed Scaling Factor Used in conjunction with P2-28.	-500.0	500.0	100.0	%
P2-30	Analog Input 1 (Terminal 6) Format U 0- 10 = 0 to 10 Volt Signal (Uni-polar) U 10-0 = 10 to 0 Volt Signal (Uni-polar) - 10- 10 = -10 to +10 Volt Signal (Bi-polar) A 0-20 = 0 to 20mA Signal t 4-20 = 4 to 20mA Signal, the VersiDrive i PRO will trip and show the fault code 4-20F if the signal level falls below 3mA r 4-20 = 4 to 20mA Signal, the VersiDrive i PRO will ramp to stop if the signal level falls below 3mA t 20-4 = 20 to 4mA Signal, the VersiDrive i PRO will trip and show the fault code 4-20F if the signal level falls below 3mA r 20-4 = 20 to 4mA Signal, the VersiDrive i PRO will ramp to stop if the signal level falls below 3mA	See Below		U 0- 10	-
P2-31	Analog Input 1 Scaling Scales the analog input by this factor, e.g. if P2-30 is set for 0 – 10V, and the scaling factor is set to 200.0%, a 5 volt input will result in the drive running at maximum speed (P1-01)	0.0	500.0	100.0	%
P2-32	Analog Input 1 Offset Sets an offset, as a percentage of the full scale range of the input, which is applied to the analog input signal	-500.0	500.0	0.0	%
P2-33	Analog Input 2 (Terminal 10) Format U 0- 10 = 0 to 10 Volt Signal (Uni-polar) U 10-0 = 10 to 0 Volt Signal (Uni-polar) Ptc-tt = Motor PTC Thermistor Input A 0-20 = 0 to 20mA Signal t 4-20 = 4 to 20mA Signal, the VersiDrive i PRO will trip and show the fault code 4-20F if the signal level falls below 3mA r 4-20 = 4 to 20mA Signal, the VersiDrive i PRO will ramp to stop if the signal level falls below 3mA t 20-4 = 20 to 4mA Signal, the VersiDrive i PRO will trip and show the fault code 4-20F if the signal level falls below 3mA r 20-4 = 20 to 4mA Signal, the VersiDrive i PRO will ramp to stop if the signal level falls below 3mA	See Below		U 0- 10	-
P2-34	Analog Input 2 Scaling Scales the analog input by this factor, e.g. if P2-30 is set for 0 – 10V, and the scaling factor is set to 200.0%, a 5 volt input will result in the drive running at maximum speed (P1-01)	0.0	500.0	100.0	%
P2-35	Analog Input 2 Offset Sets an offset, as a percentage of the full scale range of the input, which is applied to the analog input signal	-500.0	500.0	0.0	%
P2-36	Start Mode Select / Automatic Restart Defines the behaviour of the drive relating to the enable digital input and also configures the Automatic Restart function. Ed9E-r : Following Power on or reset, the drive will not start if Digital Input 1 remains closed. The Input must be closed after a power on or reset to start the drive.	See Below		Auto-0	-

Par	Parameter Name	Minimum	Maximum	Default	Units
	Auto-0 : Following a Power On or Reset, the drive will automatically start if Digital Input 1 is closed.				
	Auto-1 to Auto-5 : Following a trip, the drive will make up to 5 attempts to restart at 20 second intervals. The drive must be powered down to reset the counter. The numbers of restart attempts are counted, and if the drive fails to start on the final attempt, the drive will fault with, and will require the user to manually reset the fault. DANGER! "Auto" modes allow the drive to Auto-start, therefore the impact on system/Personnel safety needs to be considered.				

Par	Parameter Name	Minimum	Maximum	Default	Units
P2-37	Keypad Mode Restart Speed	0	3	1	-
	<p>This parameter is only active when P1-12 = 1 or 2. When settings 0 to 3 are used, the drive must be started by pressing the Start key on the keypad. When settings 4 – 7 are used, the drive starting is controlled by the enable digital input.</p> <p>0 : Minimum Speed. Following a stop and restart, the drive will always initially run at the minimum speed P1-02</p> <p>1 : Previous Operating Speed. Following a stop and restart, the drive will return to the last keypad setpoint speed used prior to stopping</p> <p>2 : Current Running Speed. Where the VersiDrive i PRO is configured for multiple speed references (typically Hand / Auto control or Local / Remote control), when switched to keypad mode by a digital input, the drive will continue to operate at the last operating speed</p> <p>3 : Preset Speed 8. Following a stop and restart, the VersiDrive i PRO will always initially run at Preset Speed 8 (P2-08)</p> <p>4 : Minimum Speed (Terminal Enable). Following a stop and restart, the drive will always initially run at the minimum speed P1-02</p> <p>5 : Previous Operating Speed (Terminal Enable). Following a stop and restart, the drive will return to the last keypad setpoint speed used prior to stopping</p> <p>6 : Current Running Speed (Terminal Enable). Where the VersiDrive i PRO is configured for multiple speed references (typically Hand / Auto control or Local / Remote control), when switched to keypad mode by a digital input, the drive will continue to operate at the last operating speed</p> <p>7 : Preset Speed 8 (Terminal Enable). Following a stop and restart, the VersiDrive i PRO will always initially run at Preset Speed 8 (P2-08)</p>				
P2-38	Mains Loss Ride Through / Stop Control	0	2	0	-
	<p>Controls the behaviour of the drive in response to a loss of mains power supply whilst the drive is enabled.</p> <p>0 : Mains Loss Ride Through. The VersiDrive i PRO will attempt to continue operating by recovering energy from the load motor. Providing that the mains loss period is short, and sufficient energy can be recovered before the drive control electronics power off, the drive will automatically restart on return of mains power</p> <p>1 : Coast To Stop. The VersiDrive i PRO will immediately disable the output to the motor, allowing the load to coast or free wheel. When using this setting with high inertia loads, the Spin Start function (P2-26) may need to be enabled</p> <p>2 : Fast Ramp To Stop. The drive will ramp to stop at the rate programmed in the 2nd deceleration time P2-25</p> <p>3 : DC Bus Power Supply Mode. This mode is intended to be used when the drive is powered directly via the +DC and –DC Bus connections. Refer to your PETER electronic Sales Partner for further details.</p>				
P2-39	Parameter Access Lock	0	1	0	-
	<p>0 : Unlocked. All parameters can be accessed and changed</p> <p>1 : Locked. Parameter values can be displayed, but cannot be changed</p>				
P2-40	Extended Parameter Access Code Definition	0	9999	101	-
	Defines the access code which must be entered in P1-14 to access parameter groups above Group 1				

8.2. Parameter Group 3 – PID Control

Par	Parameter Name	Minimum	Maximum	Default	Units
P3-01	PID Proportional Gain	0.1	30.0	1.0	-
	PID Controller Proportional Gain. Higher values provide a greater change in the drive output frequency in response to small changes in the feedback signal. Too high a value can cause instability				
P3-02	PID Integral Time Constant	0.0	30.0	1.0	s
	PID Controller Integral Time. Larger values provide a more damped response for systems where the overall process responds slowly				
P3-03	PID Differential Time Constant	0.00	1.00	0.00	s
	PID Differential Time Constant				
P3-04	PID Operating Mode	0	1	0	-
	0 : Direct Operation. Use this mode if an increase in the motor speed should result in an increase in the feedback signal 1 : Inverse Operation. Use this mode if an increase in the motor speed should result in a decrease in the feedback signal				
P3-05	PID Reference (Setpoint) Source Select	0	2	0	-
	Selects the source for the PID Reference / Setpoint 0 : Digital Preset Setpoint. P3-06 is used 1 : Analog Input 1 Setpoint 2 : Analog Input 2 Setpoint				
P3-06	PID Digital Reference (Setpoint)	0.0	100.0	0.0	%
	When P3-05 = 0, this parameter sets the preset digital reference (setpoint) used for the PID Controller				
P3-07	PID Controller Output Upper Limit	P3-08	100.0	100.0	%
	Limits the maximum value output from the PID controller				
P3-08	PID Controller Output Lower Limit	0.0	P3-07	0.0	%
	Limits the minimum output from the PID controller				
P3-09	PID Output Limit Control	0	3	0	-
	0 : Digital Output Limits. The output range of the PID controller is limited by the values of P3-07 & P3-08 1 : Analog Input 1 Provides a Variable Upper Limit. The output range of the PID controller is limited by the values of P3-08 & the signal applied to Analog Input 1 2 : Analog Input 1 Provides a Variable Lower Limit. The output range of the PID controller is limited by the signal applied to Analog Input 1 & the value of P3-07 3 : PID output Added to Analog Input 1 Value. The output value from the PID Controller is added to the speed reference applied to the Analog Input 1				
P3-10	PID Feedback Signal Source Select	0	1	0	-
	0 : Analog Input 2 1 : Analog Input 1 2 : Output Current 3 : DC Bus Voltage 4 : Differential : Analog Input 1 – Analog Input 2 5 : Largest Value : Analog Input 1 or Analog Input 2				
P3-11	Maximum PID Error to Enable Ramps	0.0	25.0	0.0	%
	Defines a threshold PID error level, whereby if the difference between the setpoint and feedback values is less than the set threshold, the internal ramp times of the drive are disabled. Where a greater PID error exists, the ramp times are enabled to limit the rate of change of motor speed on large PID errors, and react quickly to small errors. Setting to 0.0 means that the drive ramps are always enabled. This parameter is intended to allow the user to disable the drive internal ramps where a fast reaction to the PID control is required, however by only disabling the ramps when a small PID error exists, the risk of possible over current or over voltage trips being generated are reduced.				
P3-12	PID Feedback Value Display Scaling Factor	0.000	50.000	0.000	-
	Applies a scaling factor to the displayed PID feedback, allowing the user to display the actual signal level from a transducer, e.g. 0 – 10 Bar etc.				
P3-13	PID Feedback Wake Up Level	0.0	100.0	0.0	%
	Sets a programmable level whereby if the drive enters standby motor whilst operating under PID control, the selected feedback signal must fall below this threshold before the drive will return to normal operation.				
P3-18	PID Operation Control	-	-	-	-
	0 : Continuous PID Operation. In this operating mode, the PID controller operates continuously, regardless of whether the drive is enabled or disabled. This can result in the output of the PID controller reaching the maximum level prior to the drive enable signal being applied. 1 : PID operation on Drive Enable. In this operating mode, the PID controller only operates when the drive is enabled, and hence will always start from zero when the drive is enabled.				

8.3. Parameter Group 4 – High Performance Motor Control

Par	Parameter Name	Minimum	Maximum	Default	Units
 Incorrect adjustment of parameters in menu group 4 can cause unexpected behaviour of the motor and any connected machinery. It is recommended that these parameters are only adjusted by experienced users.					
P4-01	Motor Control Mode	0	2	2	-
Selects the motor control method. An autotune must be performed if setting 0 or 1 is used. 0: Speed Control with Torque Limit (vector) 1: Torque Control with Speed Limit (vector) 2: Speed Control (Enhanced V/F)					
P4-02	Motor Parameter Auto-tune Enable	0	1	0	-
When set to 1, the drive immediately carries out a non-rotating autotune to measure the motor parameters for optimum control and efficiency. Following completion of the autotune, the parameter automatically returns to 0.					
P4-03	Vector Speed Controller Proportional Gain	0.1	400.0	25.0	%
Sets the proportional gain value for the speed controller when operating in Vector Speed or Vector Torque motor control modes (P4-01 = 0 or 1). Higher values provide better output frequency regulation and response. Too high a value can cause instability or even over current trips. For applications requiring best possible performance, the value should be adjusted to suit the connected load by gradually increasing the value and monitoring the actual output speed of the load until the required dynamic behaviour is achieved with little or no overshoot where the output speed exceeds the setpoint. In general, higher friction loads can tolerate higher values of proportional gain, and high inertia, low friction loads may require the gain to be reduced.					
P4-04	Vector Speed Controller Integral Time Constant	0.000	1.000	0.050	s
Sets the integral time for the speed controller. Smaller values provide a faster response in reaction to motor load changes, at the risk of introducing instability. For best dynamic performance, the value should be adjusted to suit the connected load.					
P4-05	Motor Power Factor Cos ϕ	0.50	0.99	-	-
When operating in Vector Speed or Vector Torque motor control modes, this parameter must be set to the motor nameplate power factor					
P4-06	Torque Control Reference / Limit Source	0	5	0	-
When P4-01 = 0, this parameter defines the source for the maximum output torque limit. When P4-01 = 1, this parameter defines the source for the torque reference (setpoint). 0: Fixed Digital. The torque controller reference / limit is set in P4-07 1: Analog Input 1. The output torque is controlled based on the signal applied to Analog Input 1, whereby 100% input signal level will result in the drive output torque being limited by the value set in P4-07. 2: Analog Input 2. The output torque is controlled based on the signal applied to Analog Input 2, whereby 100% input signal level will result in the drive output torque being limited by the value set in P4-07. 3: Fieldbus. The output torque is controlled based on the signal from the communications Fieldbus, whereby 100% input signal level will result in the drive output torque being limited by the value set in P4-07. 4: Master / Slave. The output torque is controlled based on the signal from the PETER electronic Master / Slave, whereby 100% input signal level will result in the drive output torque being limited by the value set in P4-07. 5: PID Controller Output. The output torque is controlled based on the output of the PID controller, whereby 100% input signal level will result in the drive output torque being limited by the value set in P4-07.					
P4-07	Maximum Motoring Torque Limit / Current Limit	P4-08	500.0	150.0	%
When operating in Vector Speed or Vector Torque motor control modes (P4-01 = 0 or 1), this parameter defines the maximum torque limit or reference used by the drive in conjunction with P4-06. When operating in V/F Mode (P4-01 = 2), this parameter defines the maximum output current the drive will provide to the motor before reducing the output frequency to attempt to limit the current.					
P4-08	Minimum Motoring Torque Limit	0.0	P4-07	0.0	%
Active only in Vector Speed or Vector Torque motor control modes (P4-01 = 0 or 1). Sets a minimum torque limit, whereby the when the VersiDrive i PRO is enabled, it will always attempt to maintain this torque on the motor at all times whilst operating.					
 NOTE : This parameter should be used with extreme care, as the drive output frequency will increase to achieve the torque level, and may exceed the selected speed reference					
P4-09	Generator Mode Max. Torque Limit (Maximum Regenerative Torque)	0.0	200.0	100.0	%
Active only in Vector Speed or Vector Torque motor control modes (P4-01 = 0 or 1). Sets the maximum regenerating torque allowed by the VersiDrive i PRO					
P4-10	V/F Characteristic Adjustment Frequency	0.0	P1-09	0.0	Hz
When operating in V/F mode (P4-01 = 2), this parameter in conjunction with P4-11 sets a frequency point at which the voltage set in P4-11 is applied to the motor. Care must be taken to avoid overheating and damaging the motor when using this feature.					
P4-11	V/F Characteristic Adjustment Voltage	0	P1-07	0	V
Used in conjunction with parameter P4-10					
P4-12	Thermal Overload Value Retention	0	1	0	-
0 : Disabled. 1 : Enabled. All VersiDrive i PRO s feature electronic thermal overload protection for the connected motor, designed to protect the motor against damage. An internal overload accumulator monitors the motor output current over time, and will trip the drive if the usage exceeds the thermal limit. When P4-12 is disabled, removing the power supply from the drive and re-applying will reset the value of the accumulator. When P4-12 is enabled, the value is retained during power off.					

8.4. Parameter Group 5 – Communication Parameters

Par.	Name	Minimum	Maximum	Default	Units
P5-01	Drive Fieldbus Address Sets the fieldbus address for the VersiDrive i PRO	0	63	1	-
P5-02	CAN Open Baud Rate Sets the baud rate when CAN Open communications are used	125	1000	500	kbps
P5-03	Modbus RTU Baud Rate Sets the baud rate when Modbus RTU communications are used	9.6	115.2	115.2	kbps
P5-04	Modbus Data Format Sets the expected Modbus telegram data format as follows N-1 : No Parity, 1 stop bit N-2 : No parity, 2 stop bits O-1 : Odd parity, 1 stop bit E-1 : Even parity, 1 stop bit	-	-	-	-
P5-05	Communications Loss Timeout Sets the watchdog time period for the communications channel. If a valid telegram is not received by the VersiDrive i PRO within this time period, the drive will assume a loss of communications has occurred and react as selected below. Setting to zero disables the function.	0.0	5.0	2.0	Seconds
P5-06	Communications Loss Action Controls the behaviour of the drive following a loss of communications as determined by the above parameter setting. 0 : Trip & Coast To Stop 1 : Ramp to Stop Then Trip 2 : Ramp to Stop Only (No Trip) 3 : Run at Preset Speed 8	0	3	0	-
P5-07	Fieldbus Ramp Control Selects whether the acceleration and deceleration ramps are control directly via the Fieldbus, or by internal drive parameters P1-03 and P1-04. 0 : Disabled. Ramps are control from internal drive parameters 1 : Enabled. Ramps are controlled directly by the Fieldbus	0	1	0	-
P5-08	Fieldbus Process Data Output Word 4 Select When using an optional fieldbus interface, this parameter configures the parameter source for the 4 th process data word transferred from the drive to the network master during cyclic communications 0 : Output Torque – 0 to 2000 = 0 to 200.0% 1 : Output Power – Output power in kW to two decimal places, e.g. 400 = 4.00kW 2 : Digital Input Status – Bit 0 indicates digital input 1 status, bit 1 indicates digital input 2 status etc. 3 : Analog Input 2 Signal Level – 0 to 1000 = 0 to 100.0% 4 : Drive Heatsink Temperature – 0 to 100 = 0 to 100°C	0	4	0	-
P5-12	Fieldbus Process Data Output Word 3 Select When using an optional fieldbus interface, this parameter configures the parameter source for the 3 rd process data word transferred from the drive to the network master during cyclic communications 0: Motor current – Output current to 1 decimal place, e.g. 100 = 10.0 Amps 1: Power (x.xx kW) Output power in kW to two decimal places, e.g. 400 = 4.00kW 2: Digital input status – Bit 0 indicates digital input 1 status, bit 1 indicates digital input 2 status etc. 3: Analog Input 2 Signal Level - 0 to 1000 = 0 to 100.0% 4: Drive Heatsink Temperature – 0 to 100 = 0 to 100°C 5: User register 1 – User Defined Register 1 Value 6: User register 2 – User Defined Register 1 Value 7: P0-80 value – User Selected data value.	0	7	0	-
P5-13	Fieldbus Process Data Input Word 4 Select When using an optional fieldbus interface, this parameter configures destination for the 4 th process data word received by the drive from the network master during cyclic communications 0: Fieldbus Ramp Control – This option must be selected if the drive acceleration and deceleration ramps are to be controlled from the fieldbus. P5-07 must also be set to 1 to enable this function. 1: User register 4 – The value received by the drive in PDI 4 is transferred to User Register 4. This option allows the function of the process data word to be defined in Parameter Group 9. In this case, User Register 4 should not be written to within any PLC function code, although the value can be read.	0	1	0	-
P5-14	Fieldbus Process Data Input Word 3 Select When using an optional fieldbus interface, this parameter configures destination for the 3 rd process data word received by the drive from the network master during cyclic communications 0: Torque limit/reference – This option must be selected if the drive output torque limit / setpoint is to be controlled from the fieldbus. This also requires setting P4-06 = 3. 1: User PID reference register – This option allows the setpoint to the PID controller to be received from the Fieldbus. In order for this option to be used, P9-38 must be set to 1, and the PID User setpoint must not be utilised within the PLC function. 2: User register 3 - The value received by the drive in PDI 3 is transferred to User Register 3. This option allows the function of the process data word to be defined in Parameter Group 9. In this case, User Register 3 should not be written to within any PLC function code, although the value can be read.	0	2	0	-

8.5. Parameter Group 0 – Monitoring Parameters (Read Only)

Par	Description	Units
P0-01	Analog Input 1 Applied Signal Level	%
	Displays the signal level applied to analog input 1 (Terminal 6) after scaling and offsets have been applied.	
P0-02	Analog Input 2 Applied Signal Level	%
	Displays the signal level applied to analog input 2 (Terminal 10) after scaling and offsets have been applied.	
P0-03	Digital Input Status	-
	Displays the status of the drive inputs, starting with the left hand side digit = Digital Input 1 etc.	
P0-04	Pre Ramp Speed Controller Reference	Hz
	Displays the set point reference input applied to the drive internal speed controller	
P0-05	Torque Controller Reference	%
	Displays the set point reference input applied to the drive internal torque controller	
P0-06	Digital Speed Reference (Motorised Pot)	Hz
	Displays the value of the drive internal Motorised Pot (used for keypad) speed reference	
P0-07	Fieldbus Communication Speed Reference	Hz
	Displays the setpoint being received by the drive from the currently active Fieldbus interface.	
P0-08	PID Reference (Setpoint)	%
	Displays the setpoint input to the PID controller.	
P0-09	PID Feedback Level	%
	Displays the Feedback input signal to the PID controller	
P0-10	PID Controller Output	%
	Displays the output level of the PID controller	
P0-11	Applied Motor Voltage	V
	Displays the instantaneous output voltage from the drive to the motor	
P0-12	Output Torque	%
	Displays the instantaneous output torque level produced by the motor	
P0-13	Trip History Log	-
	Displays the last four fault codes for the drive. Refer to section 11.1 for further information	
P0-14	Motor Magnetising Current (Id)	A
	Displays the motor magnetising Current, providing an auto tune has been successfully completed.	
P0-15	Motor Rotor Current (Iq)	A
	Displays the motor Rotor (torque producing) current, providing an auto tune has been successfully completed.	
P0-16	DC Bus Voltage Ripple Level	V
	Displays the level of ripple present on the DC Bus Voltage. This parameter is used by the VersiDrive i PRO for various internal protection and monitoring functions.	
P0-17	Motor Stator resistance (Rs)	Ω
	Displays the measured motor stator resistance, providing an auto tune has been successfully completed.	
P0-18	Motor Stator Inductance (Ls)	H
	Displays the measured motor stator inductance, providing an auto tune has been successfully completed.	
P0-19	Motor Rotor Resistance (Rr)	Ohms
	Displays the measured motor rotor resistance, providing an auto tune has been successfully completed.	
P0-20	DC Bus Voltage	V
	Displays the instantaneous DC Bus Voltage internally within the drive	
P0-21	Drive Temperature	°C
	Displays the Instantaneous Heatsink Temperature measured by the drive	
P0-22	Time Remaining to next service	V
	Displays the number of hours remaining on the service time counter before the next service is due.	
P0-23	Operating Time Accumulated With Heatsink Temperature Above 80°C	HH:MM:SS
	Displays the amount of time in hours and minutes that the VersiDrive i PRO has operated for during its lifetime with a heatsink temperature in excess of 80°C. This parameter is used by the VersiDrive i PRO for various internal protection and monitoring functions.	
P0-24	Operating Time Accumulated With Ambient Temperature Above 80°C	HH:MM:SS
	Displays the amount of time in hours and minutes that the VersiDrive i PRO has operated for during its lifetime with an ambient temperature in excess of 80°C. This parameter is used by the VersiDrive i PRO for various internal protection and monitoring functions.	
P0-25	Rotor Speed (Estimated or Measured)	-
	In Vector control mode, this parameter displays either the estimated rotor speed of the motor, if no encoder feedback is present, or the measured rotor speed if an optional Encoder Feedback Interface Option is fitted.	
P0-26	Energy Consumption kWh Meter	kWh
	Displays the amount of energy consumed by the drive in kWh. When the value reaches 1000, it is reset back to 0.0, and the value of P0-27 (*MWh meter) is increased.	
P0-27	Energy Consumption MWh Meter	MWh
	Displays the amount of energy consumed by the drive in MWh.	
P0-28	Software Version and Checksum	-
	Displays the software version of the drive	
P0-29	Drive Type	-

Par	Description	Units
	Displays the type details of the drive	
P0-30	Drive Serial Number	-
	Displays the unique serial number of the drive.	
P0-31	Drive Lifetime Operating Time	HH:MM:SS
	Displays the total operating time of the drive. The first value shown is the number of hours. Pressing the Up key will display the minutes and seconds.	
P0-32	Drive Run Time Since Last Trip (1)	HH:MM:SS
	Displays the total operating time of the drive since the last fault occurred. The first value shown is the number of hours. Pressing the Up key will display the minutes and seconds.	
P0-33	Drive Run time Since Last Trip (2)	HH:MM:SS
	Displays the total operating time of the drive since the last fault occurred. The first value shown is the number of hours. Pressing the Up key will display the minutes and seconds.	
P0-34	Drive Run Time Since Last Disable	HH:MM:SS
	Displays the total operating time of the drive since the last Run command was received. The first value shown is the number of hours. Pressing the Up key will display the minutes and seconds.	
P0-35	Drive Internal Cooling Fan Total Operating Time	HH:MM:SS
	Displays the total operating time of the VersiDrive i PRO internal cooling fans. The first value shown is the number of hours. Pressing the Up key will display the minutes and seconds. This is used for scheduled maintenance information	
P0-36	DC Bus Voltage Log (256ms)	V
P0-37	DC Bus Voltage Ripple Log (20ms)	V
P0-38	Heatsink Temperature Log (30s)	°C
P0-39	Ambient Temperature Log (30s)	°C
P0-40	Motor Current Log (256ms)	A
	The above parameters are used to store the history of various measured levels within the drive at various regular time intervals prior to a trip. The values are frozen when a fault occurs and can be used for diagnostic purposes – see section for further information.	
P0-41	Critical Fault Counter – Over Current	-
P0-42	Critical fault counter – Over Voltage	-
P0-43	Critical fault counter – Under Voltage	-
P0-44	Critical fault counter – Over Temperature	-
P0-45	Critical fault counter – Brake Transistor Over Current	-
P0-46	Critical fault counter – Ambient Over Temperature	-
	These parameters contain a record of how many times certain critical faults have occurred during a drives operating lifetime. This provides useful diagnostic data	
P0-47	Reserved	-
	Reserved Parameter	
P0-48	Reserved	-
	Reserved Parameter	
P0-49	Modbus RTU Communication Error Counter	-
	This parameter is incremented every time an error occurs on the Modbus RTU communication link. This information can be used for diagnostic purposes.	
P0-50	CAN Open Communication Error Counter	-
	This parameter is incremented every time an error occurs on the CAN Open communication link. This information can be used for diagnostic purposes.	

9. Serial communications

9.1. RS-485 communications

„VersiDrive i PRO“ P2 has an RJ45 connector on the front of the control panel. This connector allows the user to set up a drive network via a wired connection. The connector contains two independent RS485 connections, one for PETER electronic’s Versibus Protocol and one for Modbus RTU. Both connections can be used simultaneously.

The electrical signal arrangement of the RJ45 connector is shown as follows:

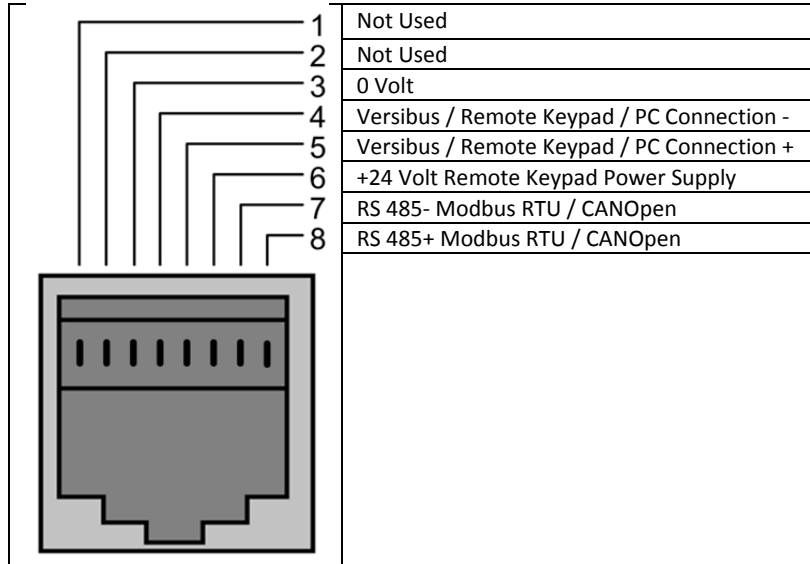

The Versibus data link uses the same communication protocol as is used for IrDA communication. This is used for the Master / Slave function (refer to the „VersiDrive i PRO“ Advanced User Guide for further information). Up to 62 slaves can be connected to one master drive.

The Modbus interface allows connection to a Modbus RTU network as described below.

9.2. Modbus RTU Communications

9.2.1. Modbus Telegram Structure

The „VersiDrive i PRO“ supports Master / Slave Modbus RTU communications, using the 03 Read Holding Registers and 06 Write Single Holding Register commands. Many Master devices treat the first Register address as Register 0; therefore it may be necessary to convert the Register Numbers detail by subtracting 1 to obtain the correct Register address. The telegram structure is as follows:-

Command 03 – Read Holding Registers							
Master Telegram		Length		Slave Response		Length	
Slave Address	1	Byte	Slave Address	1	Byte		
Function Code (03)	1	Byte	Starting Address	1	Byte		
1 st Register Address	2	Bytes	1 st Register Value	2	Bytes		
No. Of Registers	2	Bytes	2 nd Register Value	2	Bytes		
CRC Checksum	2	Bytes	Etc...				
			CRC Checksum	2	Bytes		

Command 06 – Write Single Holding Register							
Master Telegram		Length		Slave Response		Length	
Slave Address	1	Byte	Slave Address	1	Byte		
Function Code (06)	1	Byte	Function Code (06)	1	Byte		
Register Address	2	Bytes	Register Address	2	Bytes		
Value	2	Bytes	Register Value	2	Bytes		
CRC Checksum	2	Bytes	CRC Checksum	2	Bytes		

9.2.2. Modbus Control & Monitoring Registers

The following is a list of accessible Modbus Registers available in the „VersiDrive i PRO“.

- When Modbus RTU is configured as the Fieldbus option (P5-01 = 0, factory default setting), all of the listed registers can be accessed.
- Registers 1 and 2 can be used to control the drive providing that Modbus RTU is selected as the primary command source (P1-12 = 4)
- Register 3 can be used to control the output torque level providing that
 - The drive is operating in Vector Speed or Vector Torque motor control modes (P4-01 = 1 or 2)
 - The torque controller reference / limit is set for 'Fieldbus' (P4-06 = 3)
- Register 4 can be used to control the acceleration and deceleration rate of the drive providing that Fieldbus Ramp Control is enabled (P5-08 = 1)
- Registers 6 to 24 can be read regardless of the setting of P1-12

Register Number	Upper Byte	Lower Byte	Read Write	Notes
1	Command Control Word		R/W	Command control word used to control the „VersiDrive i PRO“ when operating with Modbus RTU. The Control Word bit functions are as follows :- Bit 0 : Run/Stop command. Set to 1 to enable the drive. Set to 0 to stop the drive. Bit 1 : Fast stop request. Set to 1 to enable drive to stop with 2 nd deceleration ramp. Bit 2 : Reset request. Set to 1 in order to reset any active faults or trips on the drive. This bit must be reset to zero once the fault has been cleared. Bit 3 : Coast stop request. Set to 1 to issue a coast stop command.
2	Command Speed Reference		R/W	Setpoint must be sent to the drive in Hz to one decimal place, e.g. 500 = 50.0Hz
3	Command Torque Reference		R/W	Setpoint must be sent to the drive in % to one decimal place, e.g. 2000 = 200.0%
4	Command Ramp times		R/W	This register specifies the drive acceleration and deceleration ramp times used when Fieldbus Ramp Control is selected (P5-08 = 1) irrespective of the setting of P1-12. The input data range is from 0 to 60000 (0.00s to 600.00s)
6	Error code	Drive status	R	This register contains 2 bytes. The Lower Byte contains an 8 bit drive status word as follows :- Bit 0 : 0 = Drive Disabled (Stopped), 1 = Drive Enabled (Running) Bit 1 : 0 = Drive Healthy, 1 = Drive Tripped Bit 3 : Drive Ready, 1 = Drive Inhibit Bit 4 : Maintenance Time Not Reached, 1 = Maintenance Time Reached Bit 5 : 0 = Not In Standby (Sleep), 1 = Standby (Sleep) mode active The Upper Byte will contain the relevant fault number in the event of a drive trip. Refer to section 11.1 for a list of fault codes and diagnostic information
7	Output Frequency		R	Output frequency of the drive to one decimal place, e.g.123 = 12.3 Hz
8	Output Current		R	Output current of the drive to one decimal place, e.g.105 = 10.5 Amps
9	Output Torque		R	Motor output torque level to one decimal place, e.g. 474 = 47.4 %
10	Output Power		R	Output power of the drive to two decimal places, e.g.1100 = 11.00 kW
11	Digital Input Status		R	Represents the status of the drive inputs where Bit 0 = Digital Input 1 etc
20	Analog 1 Level		R	Analog Input 1 Applied Signal level in % to one decimal place, e.g. 1000 = 100.0%
21	Analog 2 Level		R	Analog Input 2 Applied Signal level in % to one decimal place, e.g. 1000 = 100.0%
22	Pre Ramp Speed Reference		R	Internal drive frequency setpoint
23	DC bus voltages		R	Measured DC Bus Voltage in Volts
24	Drive temperature		R	Measured Heatsink Temperature in °C

9.2.3. Modbus Parameter Access

All User Adjustable parameters (Groups 1 to 5) are accessible by Modbus, except those that would directly affect the Modbus communications, e.g.

- P5-01 Communication Protocol Select
- P5-02 Drive Fieldbus Address
- P5-03 Modbus RTU Baud Rate
- P5-04 Modbus RTU Data Format

All parameter values can be read from the drive and written to, depending on the operating mode of the drive – some parameters cannot be changed whilst the drive is enabled for example.

When accessing a drive parameter via Modbus, the Register number for the parameter is the same as the parameter number, E.g. Parameter P1-01 = Modbus Register 101.

Modbus RTU supports sixteen bit integer values, hence where a decimal point is used in the drive parameter, the register value will be multiplied by a factor of ten,

E.g. Read Value of P1-01 = 500, therefore this is 50.0Hz.

For further details on communicating with „VersiDrive i PRO“ using Modbus RTU, please refer to your local PETER electronic Sales Partner.

10. Technical Data

10.1. Environmental

Ambient temperature range: Operational : -10 ... 50 °C (Refer to section 10.4 for more Information)
 Storage and Transportation : -40 °C ... 60 °C
 Max altitude for rated operation : 1000m
 Relative Humidity : < 95% (non condensing)
 Note : Drive must be Frost and moisture free at all times
 Installation above 2000m is not UL approved

10.2. Input / Output Power and Current ratings

The following tables provide the output current rating information for the various VersiDrive i PRO models. PETER electronic Drives always recommend that selection of the correct VersiDrive i PRO is based upon the motor full load *current* at the incoming supply voltage.

200 - 240 Volt (+ / - 10%) 1 Phase Input, 3 Phase Output											
kW	HP	Nominal Input Current	Fuse Or MCB (Type B)		Supply Cable Size		Nominal Output Current	Motor Cable Size		Maximum Motor Cable Length	Recommended Brake Resistance Ω
			Non UL	UL	mm	AWG / kcmil		mm	AWG		
0.75	1	10.5	16	15	2.5	12	4.3	1.5	14	100	100
1.5	2	16.2	20	20	4	10	7	1.5	14	100	50
2.2	3	23.8	25	25	10	8	10.5	1.5	14	100	35

Note

- Ratings shown above apply to 40°C Ambient temperature. For derating information, refer to section 10.4
- The maximum motor cable length stated applies to using a shielded motor cable. When using an unshielded cable, the maximum cable length limit may be increased by 50%. When using the PETER electronic Drives recommended output choke, the maximum cable length may be increased by 100%
- The PWM output switching from any inverter when used with a long motor cable length can cause an increase in the voltage at the motor terminals, depending on the motor cable length and inductance. The rise time and peak voltage can affect the service life of the motor. PETER electronic Drives recommend using an output choke for motor cable lengths of 50m or more to ensure good motor service life
- For UL compliant installation, use Copper wire with a minimum insulation temperature rating of 70°C, UL Class CC or Class J Fuses

200 - 240 Volt (+ / - 10%) 3 Phase Input, 3 Phase Output											
kW	HP	Nominal Input Current	Fuse Or MCB (Type B)		Supply Cable Size		Nominal Output Current	Motor Cable Size		Maximum Motor Cable Length	Recommended Brake Resistance Ω
			Non UL	UL (A)	mm	AWG / kcmil		mm	AWG / kcmil		
0.75	1	3.7	10	6	1.5	14	4.3	1.5	14	100	100
1.5	2	5.9	10	10	1.5	14	7	1.5	14	100	50
2.2	3	7.9	10	10	1.5	14	10.5	1.5	14	100	35
4	5	16.3	25	25	4	10	18	2.5	10	100	20
5.5	7.5	22.5	32	30	6	10	24	4	10	100	20
7.5	10	32.9	50	45	16	8	30	6	8	100	22
11	15	54.1	80	70	25	4	46	10	6	100	22
15	20	69.6	100	90	35	3	61	16	4	100	12
18.5	25	76.9	100	100	35	3	72	25	3	100	12
22	30	92.3	125	125	50	1	90	35	2	100	6
30	40	116.9	160	150	70	1/0	110	50	1/0	100	6
37	50	150.2	200	200	95	3/0	150	70	3/0	100	6
45	50	176.5	250	225	120	4/0	180	95	4/0	100	6
55	50	211	300	300	185	300	202	120	250	100	6
75	50	267	400	350	2 x 95	400	248	150	350	100	6

Note

- Ratings shown above apply to 40°C Ambient temperature. For derating information, refer to section 10.4
- The maximum motor cable length stated applies to using a shielded motor cable. When using an unshielded cable, the maximum cable length limit may be increased by 50%. When using the PETER electronic Drives recommended output choke, the maximum cable length may be increased by 100%
- The PWM output switching from any inverter when used with a long motor cable length can cause an increase in the voltage at the motor terminals, depending on the motor cable length and inductance. The rise time and peak voltage can affect the service life of the motor. PETER electronic Drives recommend using an output choke for motor cable lengths of 50m or more to ensure good motor service life
- For UL compliant installation, use Copper wire with a minimum insulation temperature rating of 70°C, UL Class CC or Class J Fuses

380 - 480 Volt (+ / - 10%) 3 Phase Input, 3 Phase Output											
kW (400V)	HP (460V)	Nominal Input Current	Fuse Or MCB (Type B)		Supply Cable Size		Nominal Output Current	Motor Cable Size		Maximum Motor Cable Length	Recommended Brake Resistance Ω
			Non UL	UL (A)	mm	AWG / kcmil		mm	AWG / kcmil		
0.75	1	2	10	6	1.5	14	2.2	1.5	14	100	400
1.5	2	5.1	10	10	1.5	14	4.1	1.5	14	100	200
2.2	3	7.7	10	10	1.5	14	5.8	1.5	14	100	150
4	5	11.7	16	15	2.5	14	9.5	1.5	14	100	100
5.5	7.5	14.1	20	20	4	12	14	1.5	12	100	75
7.5	10	18.3	25	25	4	10	18	2.5	10	100	50
11	15	27	40	35	10	8	24	4	10	100	40
15	20	29	40	40	10	8	30	6	8	100	22
18.5	25	39.7	50	50	16	8	39	10	8	100	22
22	30	48.6	63	70	16	6	46	10	6	100	22
30	40	61.5	80	80	25	4	61	16	4	100	12
37	50	72.3	100	100	35	3	72	25	3	100	12
45	60	91.2	125	125	50	2	90	35	2	100	6
55	75	116.9	160	150	70	1/0	110	50	1/0	100	6
75	100	150.2	200	200	95	3/0	150	70	3/0	100	6
90	150	176.5	250	225	120	4/0	180	95	4/0	100	6
110	175	217.2	300	300	185	300	202	120	250	100	6
132	200	255.7	400	350	2 x 95	400	240	150	350	100	6
160	200	302.4	400	400	2 x 95	500	302	2 x 70	500	100	6
200	200	370	500	500	2 x 150	750	370	2 x 95	750	100	2
250	200	450	600	600	2 x 150	1250	450	2 x 120	1250	100	2

Note

- Ratings shown above apply to 40°C Ambient temperature. For derating information, refer to section 10.4
- The maximum motor cable length stated applies to using a shielded motor cable. When using an unshielded cable, the maximum cable length limit may be increased by 50%. When using the PETER electronic Drives recommended output choke, the maximum cable length may be increased by 100%
- The PWM output switching from any inverter when used with a long motor cable length can cause an increase in the voltage at the motor terminals, depending on the motor cable length and inductance. The rise time and peak voltage can affect the service life of the motor. PETER electronic Drives recommend using an output choke for motor cable lengths of 50m or more to ensure good motor service life
- For UL compliant installation, use Copper wire with a minimum insulation temperature rating of 70°C, UL Class CC or Class J Fuses
- Data values shown in *Italics* are provisional

10.3. Additional Information for UL Approved Installations

VersiDrive i PRO is designed to meet the UL requirements. In order to ensure full compliance, the following must be fully observed.

Input Power Supply Requirements				
Supply Voltage	200 – 240 RMS Volts for 230 Volt rated units, + / - 10% variation allowed. 240 Volt RMS Maximum			
	380 – 480 Volts for 400 Volt rated units, + / - 10% variation allowed, Maximum 500 Volts RMS			
Imbalance	Maximum 3% voltage variation between phase – phase voltages allowed			
	All VersiDrive i PRO units have phase imbalance monitoring. A phase imbalance of > 3% will result in the drive tripping. For input supplies which have supply imbalance greater than 3% (typically the Indian sub- continent & parts of Asia Pacific including China) PETER electronic Drives recommends the installation of input line reactors. Alternatively, the drives can be operated as a single phase supply drive with 50% derating.			
Frequency	50 – 60Hz + / - 5% Variation			
Short Circuit Capacity	Voltage Rating	Min kW (HP)	Max kW (HP)	Maximum supply short-circuit current
	230V	0.37 (0.5)	18.5 (25)	100kA rms (AC)
	230V	22 (30)	75 (100)	100kA rms (AC)
	400 / 460V	0.75 (1)	37 (50)	100kA rms (AC)
	400 / 460V	45 (60)	132 (200)	100kA rms (AC)
	400 / 460V	160 (250)	250 (350)	100kA rms (AC)
	All the drives in the above table are suitable for use on a circuit capable of delivering not more than the above specified maximum short-circuit Amperes symmetrical with the specified maximum supply voltage.			
Incoming power supply connection must be according to section 4.3.				
All VersiDrive i PRO units are intended for indoor installation within controlled environments which meet the condition limits shown in section 10.1.				
Branch circuit protection must be installed according to the relevant national codes. Fuse ratings and types are shown in section 10.2.				
Suitable Power and motor cables should be selected according to the data shown in section 10.2.				
Power cable connections and tightening torques are shown in section 3.4.				
VersiDrive i PRO provides motor overload protection in accordance with the National Electrical Code (US).				
<ul style="list-style-type: none"> • Where a motor thermistor is not fitted, or not utilised, Thermal Overload Memory Retention must be enabled by setting P4-12 = 1 • Where a motor thermistor is fitted and connected to the drive, connection must be carried out according to the information shown in section 4.7. 				

10.4. Derating Information

Derating of the drive maximum continuous output current capacity is require when

- Operating at ambient temperature in excess of 40°C / 104°F
- Operating at Altitude in excess of 1000m/ 3281 ft
- Operation with Effective Switching Frequency higher than the minimum setting

The following derating factors should be applied when operating drives outside of these conditions

10.4.1. Derating for Ambient Temperature

Enclosure Type	Maximum Temperature Without Derating	Derate by	Maximum Permissable
IP20	50°C / 122°F	N/A	50°C
IP55	40°C / 104°F	1.5% per °C (1.8°F)	50°C
IP66	40°C / 104°F	2.5% per °C (1.8°F)	50°C

10.4.2. Derating for Altitude

Enclosure Type	Maximum Altitude Without Derating	Derate by	Maximum Permssable (UL Approved)	Maximum Permssable (Non-UL Approved)
IP20	1000m / 3281ft	1% per 100m / 328 ft	2000m / 6562 ft	4000m / 13123 ft
IP55	1000m / 3281ft	1% per 100m / 328 ft	2000m / 6562 ft	4000m / 13123 ft
IP66	1000m / 3281ft	1% per 100m / 328 ft	2000m / 6562 ft	4000m / 13123 ft

10.4.3. Derating for Swicthing Frequency

Enclosure Type	Switching Frequency (Where available)					
	4kHz	8kHz	12kHz	16kHz	24kHz	32kHz
IP20	N/A	N/A	20%	30%	40%	50%
IP55	N/A	10%	10%	15%	25%	N/A
IP66	N/A	10%	25%	35%	50%	50%

10.4.4. Example of applying Derating Factors

A 4kW, IP66 drive is to be used at an altitude of 2000 metres above sea level, with 12kHz switching frequency and 45°C ambient temperature.

From the table above, we can see that the rated current of the drive is 9.5 Amps at 40°C,

Firstly, apply the swicthing frequency derating, 12kHz, 25% derating

$$9.5 \text{ Amps} \times 75\% = 7.1 \text{ Amps}$$

Now, apply the derating for higher ambient temperature, 2.5% per °C above 40°C = 5 x 2.5% = 12.5%

$$7.1 \text{ Amps} \times 87.5\% = 6.2 \text{ Amps}$$

Now apply the derating for altitude above 1000 metres, 1% per 100m above 1000m = 10 x 1% = 10%

$$7.9 \text{ Amps} \times 90\% = 5.5 \text{ Amps continuous current available.}$$

If the required motor current exceeds this level, it will be necessary to either

- Reduce the switching frequency selected
- Use a higher power rated drive and repeat the calculation to ensure sufficient output current is available.

11. Troubleshooting

11.1. Fault messages

Fault Code	No.	Description	Corrective Action
no-FLt	00	No Fault	Displayed in P0-13 if no faults are recorded in the log
Ol-b	01	Brake channel over current	Ensure the connected brake resistor is above the minimum permissible level for the drive – refer to the ratings shown in section 10.2. Check the brake resistor and wiring for possible short circuits.
OL-br	02	Brake resistor overload	The drive software has determined that the brake resistor is overloaded, and trips to protect the resistor. Always ensure the brake resistor is being operated within its designed parameter before making any parameter or system changes. To reduce the load on the resistor, increase deceleration the time, reduce the load inertia or add further brake resistors in parallel, observing the minimum resistance value for the drive in use.
O-I	03	Instantaneous over current on drive output. Excess load on the motor.	Fault Occurs on Drive Enable Check the motor and motor connection cable for phase – phase and phase – earth short circuits. Check the load mechanically for a jam, blockage or stalled condition Ensure the motor nameplate parameters are correctly entered, P1-07, P1-08, P1-09. If operating in Vector mode (P4-01 – 0 or 1), also check the motor power factor in P4-05 and ensure an autotune has been successfully completed for the connected motor. Reduced the Boost voltage setting in P1-11 Increase the ramp up time in P1-03 If the connected motor has a holding brake, ensure the brake is correctly connected and controlled, and is releasing correctly Fault Occurs When Running If operating in Vector mode (P4-01 – 0 or 1), reduce the speed loop gain in P4-03
I.Lt-trP	04	Drive has tripped on overload after delivering >100% of value in P1-08 for a period of time.	Check to see when the decimal points are flashing (drive in overload) and either increase acceleration rate or reduce the load. Check motor cable length is within the limit specified for the relevant drive in section 10.2. Ensure the motor nameplate parameters are correctly entered in P1-07, P1-08, and P1-09 If operating in Vector mode (P4-01 – 0 or 1), also check the motor power factor in P4-05 and ensure an autotune has been successfully completed for the connected motor. Check the load mechanically to ensure it is free, and that no jams, blockages or other mechanical faults exist
PS-trP	05	Hardware Over Current	Check the wiring to motor and the motor for phase to phase and phase to earth short circuits. Disconnect the motor and motor cable and retest. If the drive trips with no motor connected, it must be replaced and the system fully checked and retested before a replacement unit is installed.
O-vOLt	06	Over voltage on DC bus	The value of the DC Bus Voltage can be displayed in P0-20 A historical log is stored at 256ms intervals prior to a trip in parameter P0-36 This fault is generally caused by excessive regenerative energy being transferred from the load back to the drive. When a high inertia or over hauling type load is connected. If the fault occurs on stopping or during deceleration, increase the deceleration ramp time P1-04 or connect a suitable brake resistor to the drive. If operating in Vector Mode, reduce the speed loop gain P4-03 If operating in PID control, ensure that ramps are active by reducing P3-11
U-vOLt	07	Under voltage on DC bus	This occurs routinely when power is switched off. If it occurs during running, check the incoming supply voltage, and all connections into the drive, fuses, contactors etc.
O-t	08	Heatsink over temperature	The heatsink temperature can be displayed in P0-21. A historical log is stored at 30 second intervals prior to a trip in parameter P0-38 Check the drive ambient temperature Ensure the drive internal cooling fan is operating Ensure that the required space around the drive as shown in sections 3.7 / 3.9 and 3.10 has been observed, and that the cooling airflow path to and from the drive is not restricted Reduce the effective switching frequency setting in parameter P2-24 Reduce the load on the motor / drive
U-t	09	Under temperature	Trip occurs when ambient temperature is less than -10°C. The temperature must be raised over -10°C in order to start the drive.
P-dEF	10	Factory Default parameters have been loaded	Press STOP key, the drive is now ready to be configured for the required application
E-tr iP	11	External trip	E-trip requested on control input terminals. Some settings of P1-13 require a normally closed contactor to provide an external means of tripping the drive in the event that an external device develops a fault. If a motor thermistor is connected check if the motor is too hot.
SC-ObS	12	Communications Fault	Communications lost with PC or remote keypad. Check the cables and connections to external devices
FLt-dc	13	Excessive DC Ripple	The DC Bus Ripple Voltage level can be displayed in parameter P0-22 A historical log is stored at 20ms intervals prior to a trip in parameter P0-39 Check all three supply phases are present and within the 3% supply voltage level imbalance tolerance. Reduce the motor load If the fault persists, contact your local PETER electronic Drives Sales Partner
P-LoSS	14	Input phase loss trip	Drive intended for use with a 3 phase supply, one input phase has been disconnected or lost.

Fault Code	No.	Description	Corrective Action
h 0-1	15	Instantaneous over current on drive output.	Refer to fault 3 above
th-FLt	16	Faulty thermistor on heatsink.	Refer to your PETER electronic Sales Partner.
dARA-F	17	Internal memory fault.	Parameters not saved, defaults reloaded. Try again. If problem recurs, refer to your IDL Authorised Distributor.
4-20F	18	4-20mA Signal Lost	The reference signal on Analog Input 1 or 2 (Terminals 6 or 10) has dropped below the minimum threshold of 3mA. Check the signal source and wiring to the VersiDrive i PRO terminals.
dARA-E	19	Internal memory fault.	Parameters not saved, defaults reloaded. Try again. If problem recurs, refer to your IDL Authorised Distributor.
U-dEF	20	User Parameter Defaults	User Parameter defaults have been loaded. Press the Stop key.
F-Plc	21	Motor PTC Over Temperature	The connected motor PTC device has caused the drive to trip
FAn-F	22	Cooling Fan Fault	Check and if necessary, replace the drive internal cooling fan
0-hEAt	23	Ambient Temperature too High	The measured temperature around the drive is above the operating limit of the drive. Ensure the drive internal cooling fan is operating Ensure that the required space around the drive as shown in sections 3.7 / 3.9 and 3.10 has been observed, and that the cooling airflow path to and from the drive is not restricted Increase the cooling airflow to the drive Reduce the effective switching frequency setting in parameter P2-24 Reduce the load on the motor / drive
0-tor9	24	Maximum Torque Limit Exceeded	The output torque limit has exceeded the drive capacity or trip threshold Reduce the motor load, or increase the acceleration time
U-tor9	25	Output Torque Too Low	Active only when hoist brake control is enabled P2-18 = 8. The torque developed prior to releasing the motor holding brake is below the preset threshold. Contact your local PETER electronic Sales Partner for further information on using the VersiDrive i PRO in hoist applications.
OUt-F	26	Drive output fault	Drive output fault
Sto-F	29	Internal STO circuit Error	Refer to your PETER electronic Sales Partner
Enc-01	30	Encoder Feedback Faults	Encoder communication /data loss
Enc-02	31	Speed Error	Encoder Speed Error. The error between the measured encoder feedback speed and the VersiDrive i PRO estimated rotor speed is greater than the pre-set limit allowed.
Enc-03	32	Encoder Feedback Faults	Incorrect Encoder PPR count set in parameters
Enc-04	33	Encoder Feedback Faults	Encoder Channel A Fault
Enc-05	34	Encoder Feedback Faults	Encoder Channel B Fault
Enc-06	35	Encoder Feedback Faults	Encoder Channels A & B Fault
AtF-01	40	Autotune Failed	Measured motor stator resistance varies between phases. Ensure the motor is correctly connected and free from faults. Check the windings for correct resistance and balance.
AtF-02	41		Measured motor stator resistance is too large. Ensure the motor is correctly connected and free from faults. Check that the power rating corresponds to the power rating of the connected drive.
AtF-03	42		Measured motor inductance is too low. Ensure the motor is correctly connected and free from faults.
AtF-04	43		Measured motor inductance is too large. Ensure the motor is correctly connected and free from faults. Check that the power rating corresponds to the power rating of the connected drive.
AtF-05	44		Measured motor parameters are not convergent. Ensure the motor is correctly connected and free from faults. Check that the power rating corresponds to the power rating of the connected drive.
OUt-Ph	49	Output (Motor) Phase Loss	One of the motor output phases is not connected to the drive.
Sc-F01	50	Modbus comms fault	A valid Modbus telegram has not been received within the watchdog time limit set in P5-06 Check the network master / PLC is still operating Check the connection cables Increase the value of P5-05 to a suitable level
Sc-F02	51	CAN Open comms trip	A valid CAN open telegram has not been received within the watchdog time limit set in P5-06 Check the network master / PLC is still operating Check the connection cables Increase the value of P5-06 to a suitable level
Sc-F03	52	Communications Option Module Fault	Internal communication to the inserted Communication Option Module has been lost. Check the module is correctly inserted
Sc-F04	53	IO card comms trip	Internal communication to the inserted Option Module has been lost. Check the module is correctly inserted

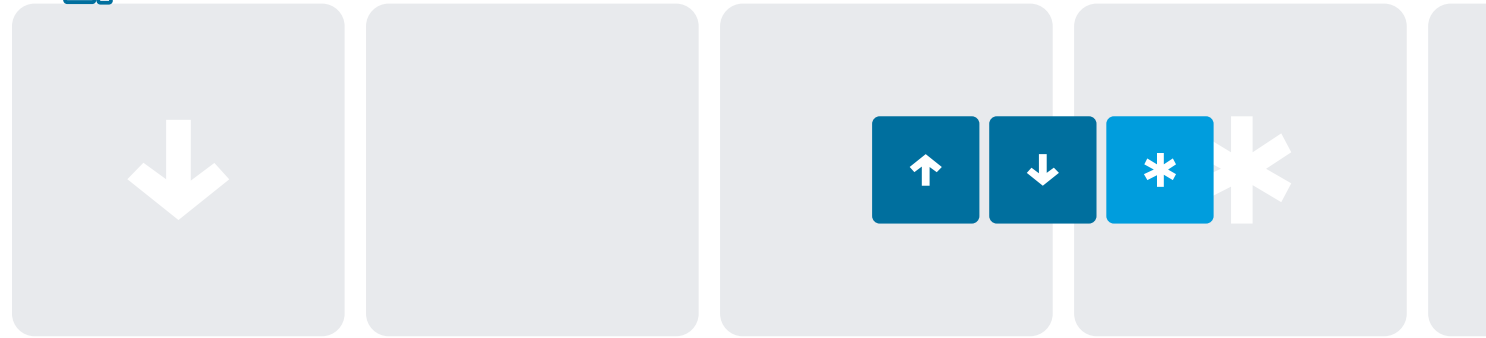

82-P2MAN-PET_V1.30